

aqua

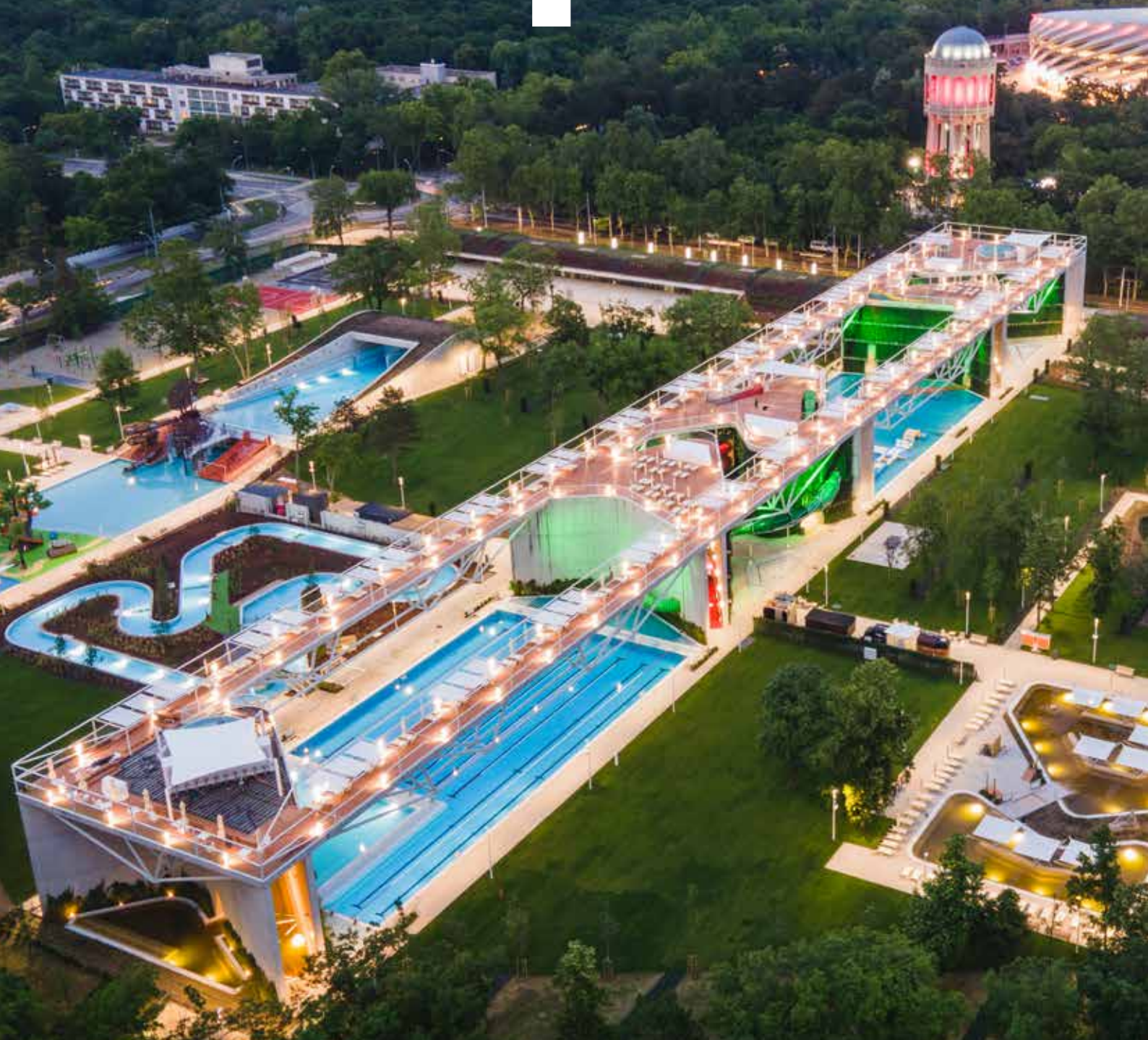

ROSA
GRES

INDEX

INTRODUCTION	pg. 03
PROJECTS	pg. 04
THE EDGE. DECK LEVEL POOL SYSTEMS	pg. 08
THE TANK	pg. 14
CHANGING ROOMS	pg. 18
POOL DECKS	pg. 20
POOL DECKS. OTHER COLORS	pg. 22
ACCESSORIES	pg. 24
TECHNICAL INFORMATION	pg. 26

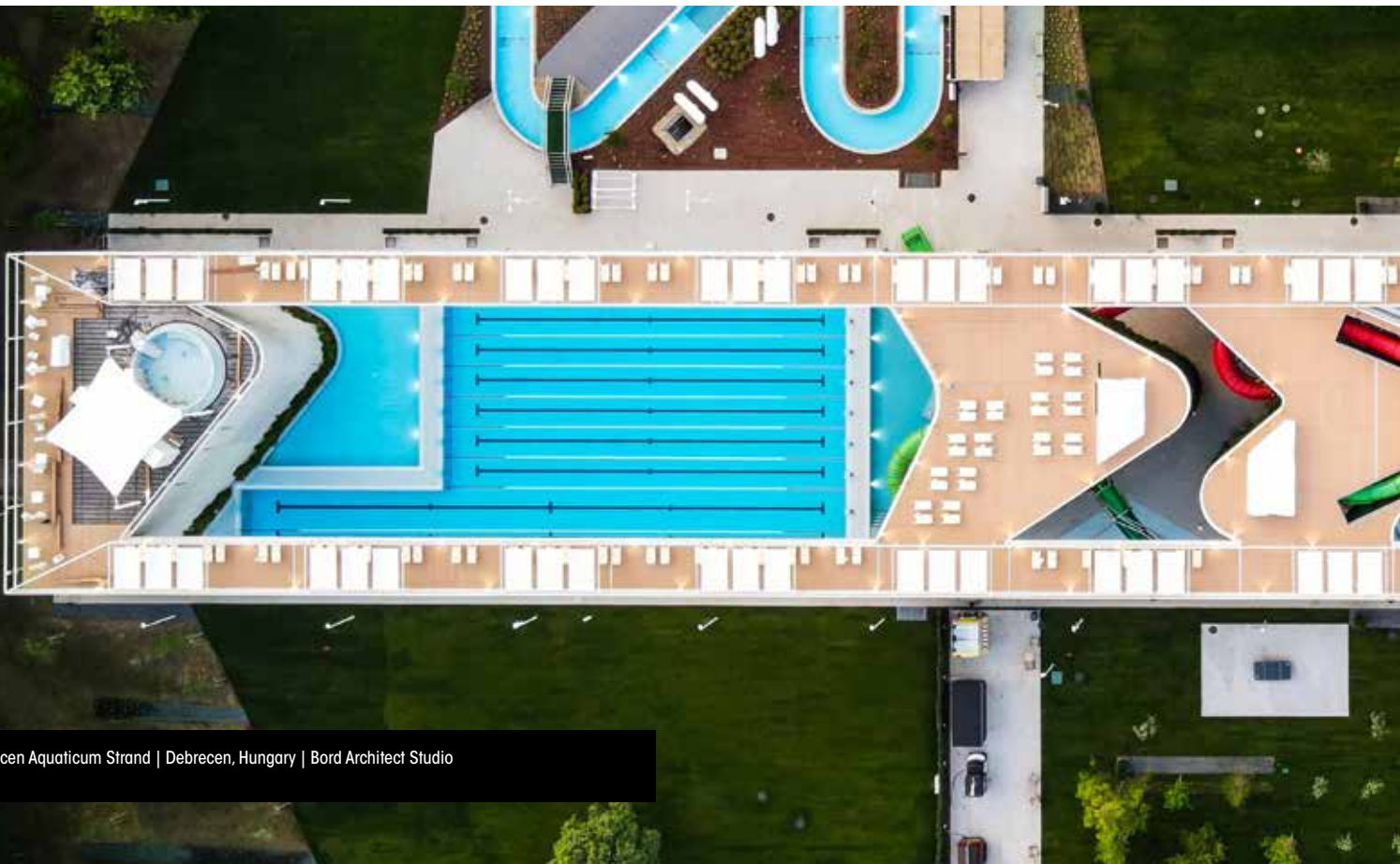

AQUA BY ROSA GRES: UNIQUE SOLUTIONS FOR UNIQUE POOLS

Rosa Gres is a company specialized in manufacturing **porcelain stoneware solutions for pools, wellness-spa centers and terraces.**

With more than 40 years' experience, we cooperate with **projects from all over the world:** Olympic pools, sports clubs, private pools, hotel pools and wellness centers.

Our focus on **innovation + design** has revolutionized the technical and esthetic universe of pools with practical and thought-provoking concepts such as:

Aqua, the specific range of pieces and colors for lining competition pools. With pieces to cover everything from the deck to the pool tank. Designed and manufactured in accordance with the sector's strictest regulations.

Technical solutions for building all kinds of pools. With construction systems for deck-level pools and many different trim pieces.

Anti-slip finishes that are extremely safe thanks to their suction effect. They are pleasant to touch and easy to clean.

Innovative **porcelain stoneware grids.** With perfect drainage and heightened esthetics.

Wide range of colors and textures. They make it easier to create personal designs that help the pool seamlessly blend into its surroundings.

Indugres. Our **antibacterial porcelain stoneware.** Perfect for changing rooms.

BIM tech. We work on our projects using our very own BIM objects to better visualize them with hyper-realistic precision.

We help achieve **Zero maintenance** facilities.

We hope this catalogue inspires you to create wonderful projects where water takes center stage.

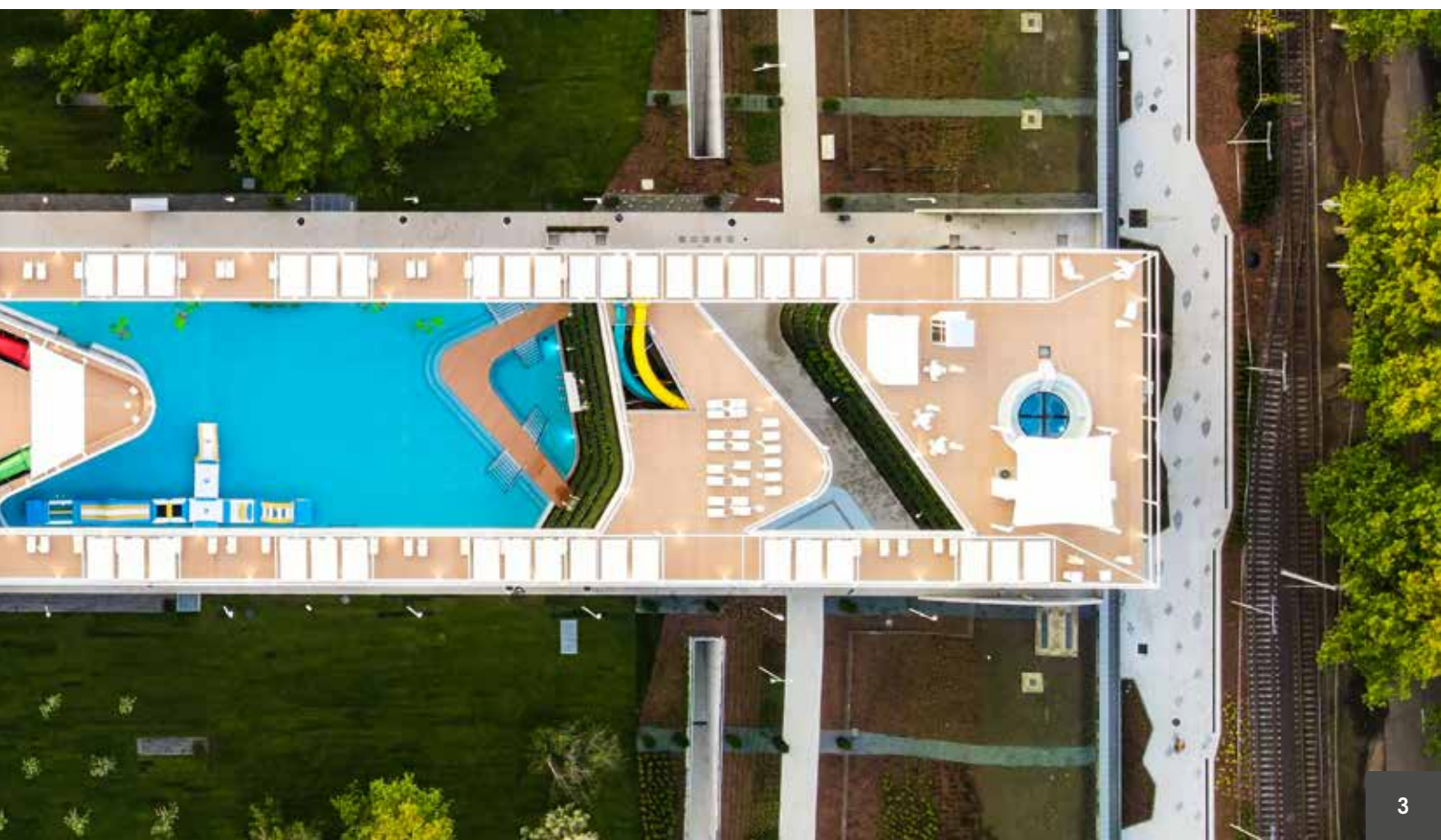

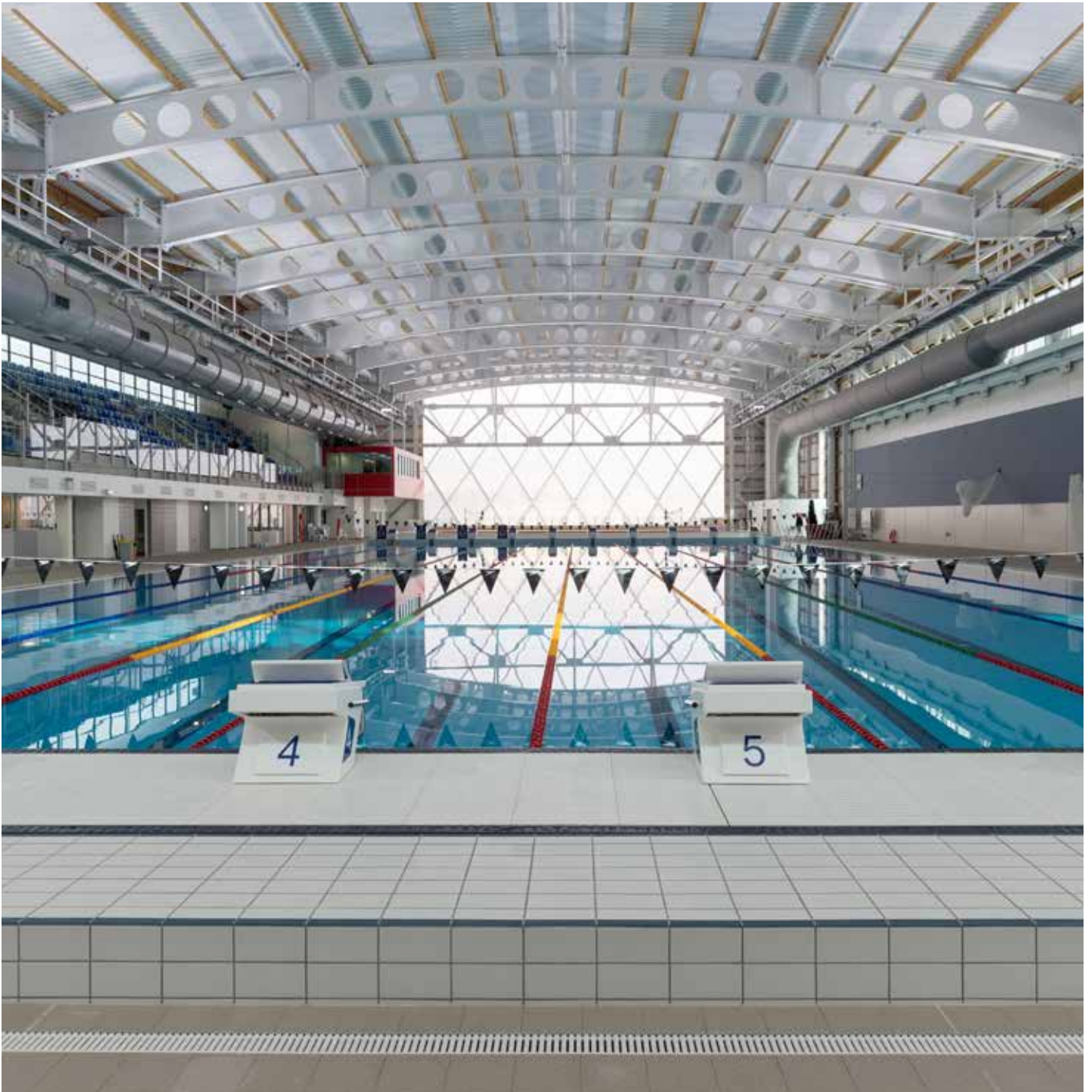

**SIR OWEN G.GLENN NATIONAL AQUATIC CENTER
AUCKLAND, NEW ZEALAND**

Ergo System



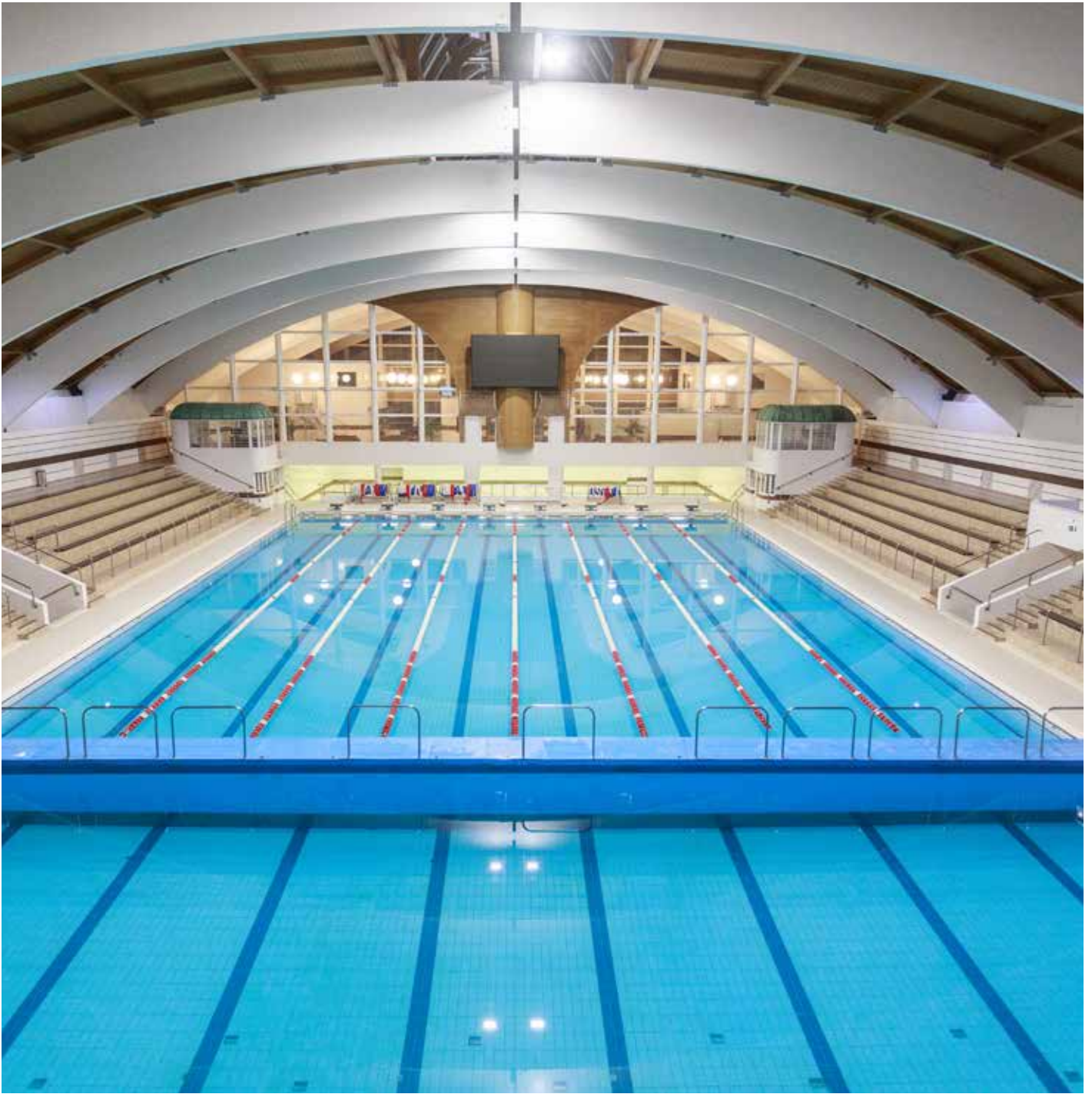

**NYEKI IMRE SWIMMING CENTER
BUDAPEST, HUNGARY**

Finnish System



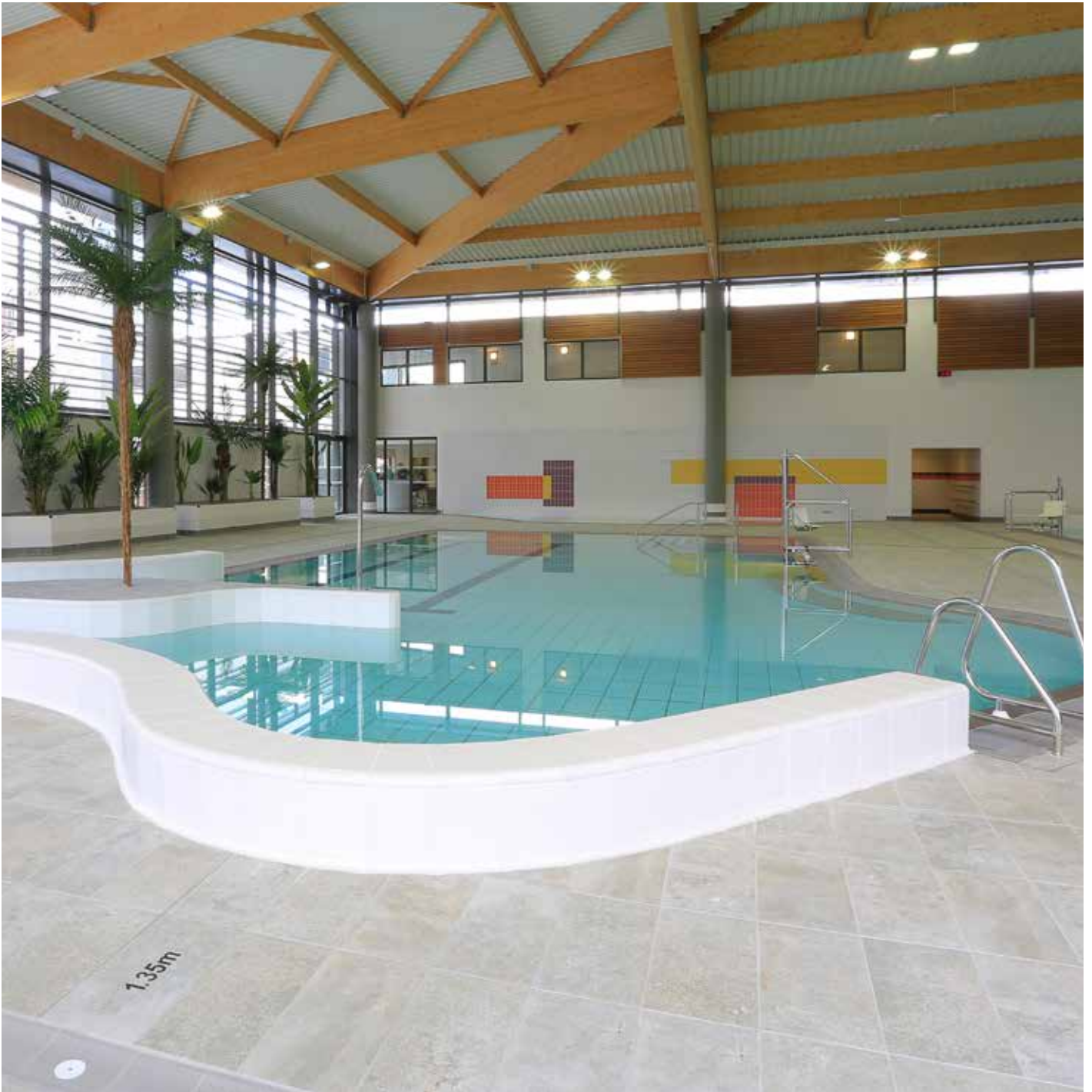

**PISCINE MUNICIPALE LA TESTE-DE-BUCH
LA TESTE-DE-BUCH, FRANCE**

Architect
Atelier Arcos Architecture

Ergo System



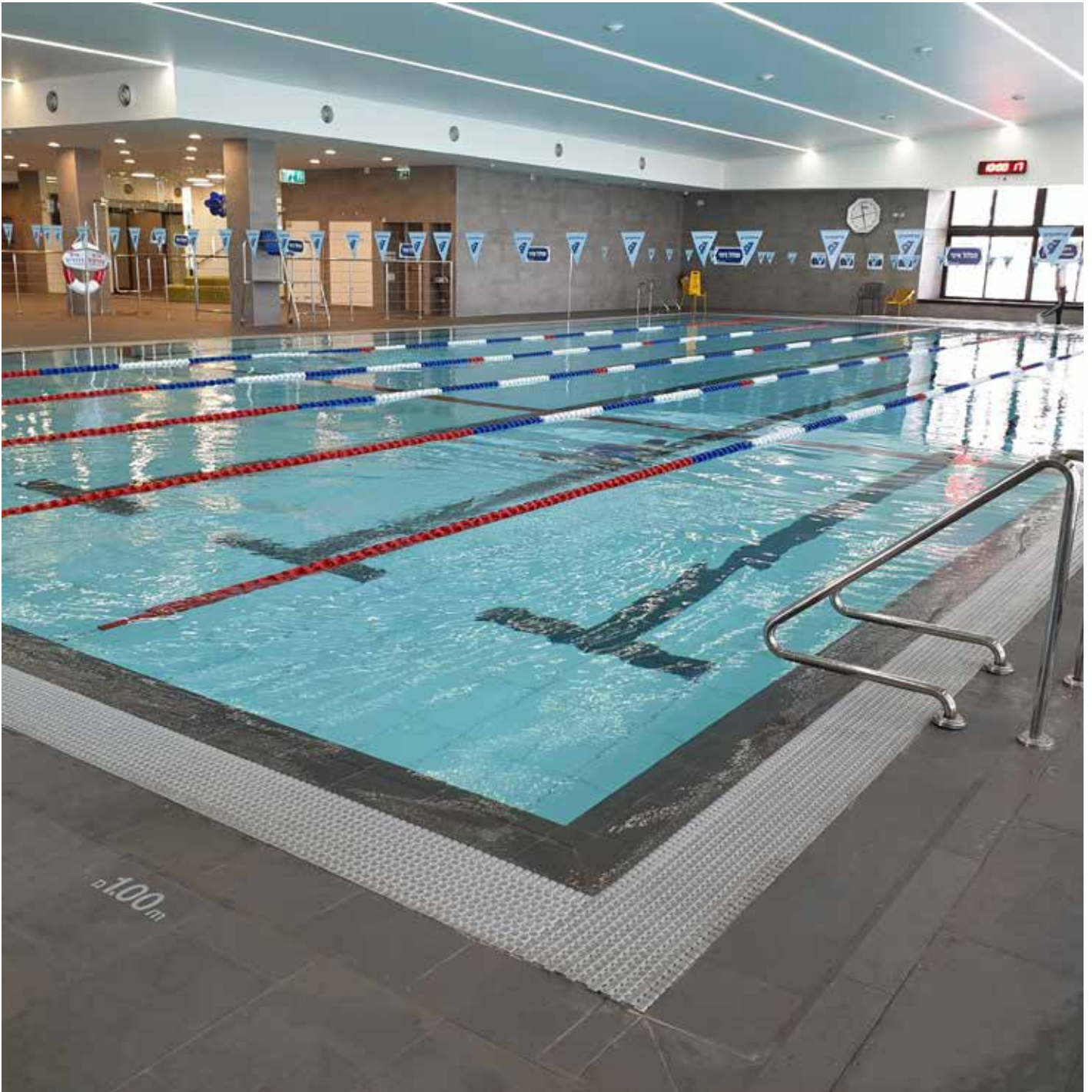

**ARLOZOROV 97 SPORTS CENTER, TEL AVIV,
ISRAEL**

Architect
Mayslits Kassif Roytman Architects

Finnish System



Finnish System

A classic downward-sloping pre-deck system. The S9 blocks provide the necessary slope and grate support.

007

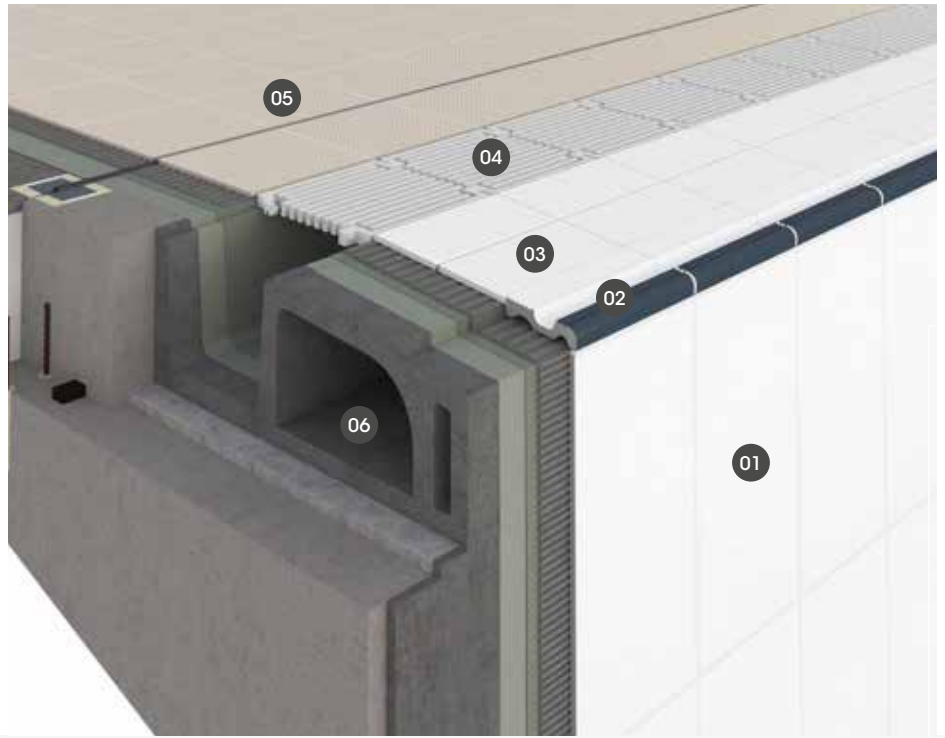
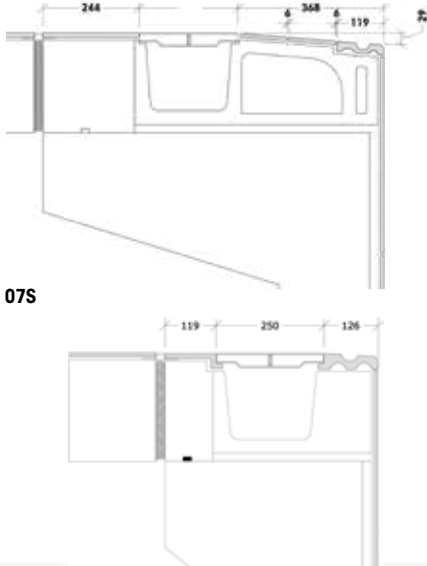

- 01** 244 smooth / anti-slip
Blanco
24,4 x 49,4 cm
Porcelain tile
- 02** 007 anti-slip
Blanco
24,4 x 11,9 cm
Porcelain tile
- 03** 001 anti-slip
Blanco
11,9 x 24,4 cm
Porcelain tile
- 04** Plastic grid
- 05** 240 pastilla
Indubeige
24,4 x 24,4 cm
Porcelain tile
- 06** RS 911
S9 System Block
61,2 x 19,5 x 21,5 cm

Edging tiles and corners

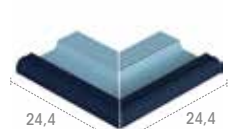
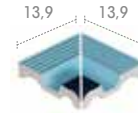
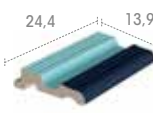
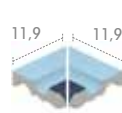
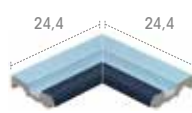
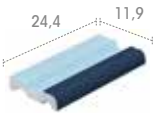
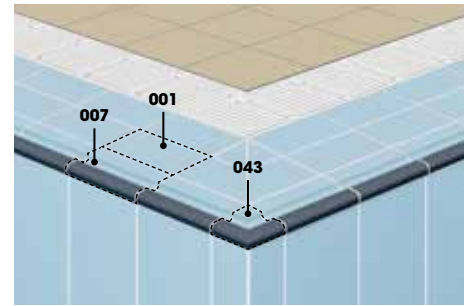
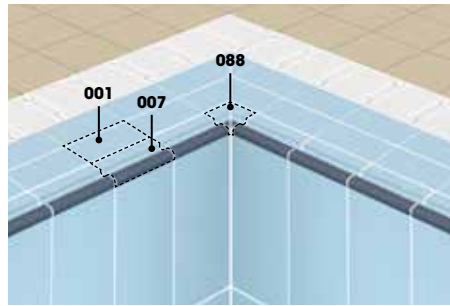
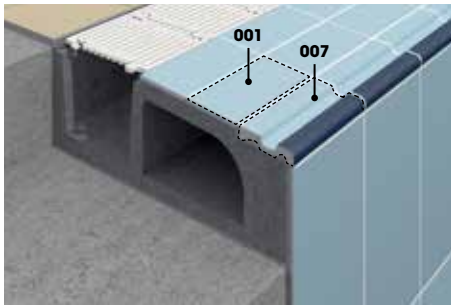

007

087

088

043

07S

88S

43S

anti-slip

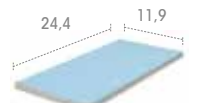
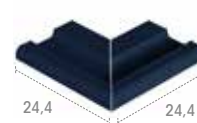
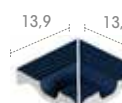
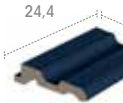
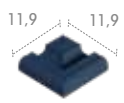
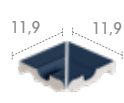
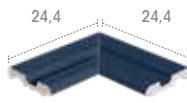
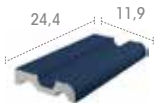
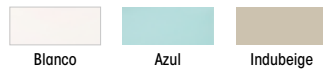

007M

087M

088M

043M

07SM

88SM

43SM

001

anti-slip

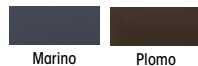

anti-slip



* For black stripes or stripes of any other color, check availability and/or conditions.

Wiesbaden System

This is ideal if you have a limited pool deck area and require a low price, guaranteed watertightness, a high-capacity channel, an easy installation and a wide range of colors.

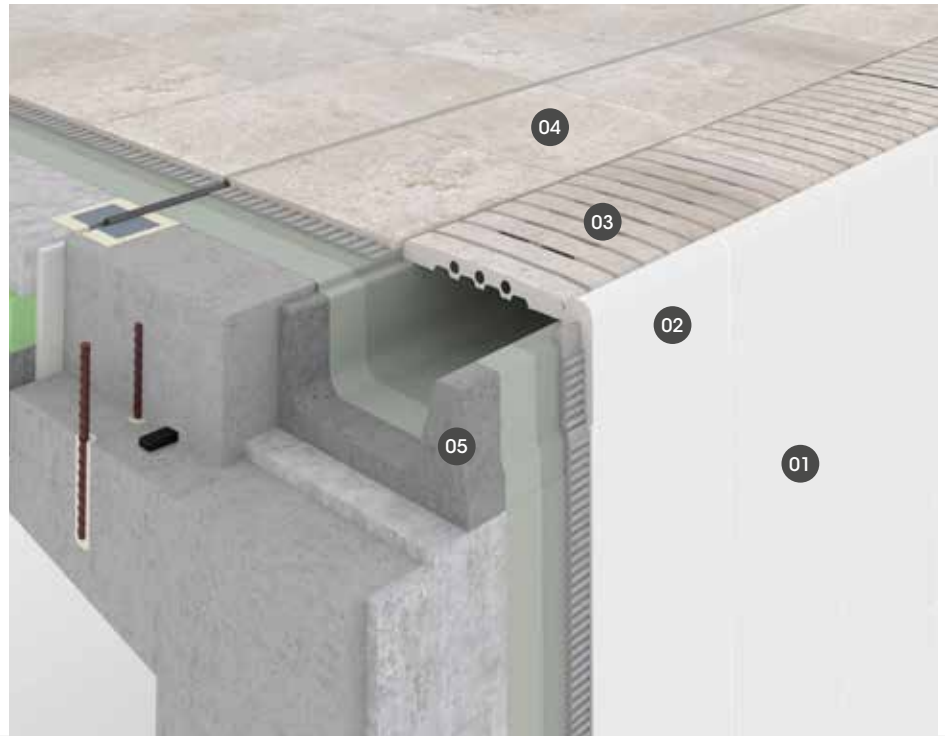
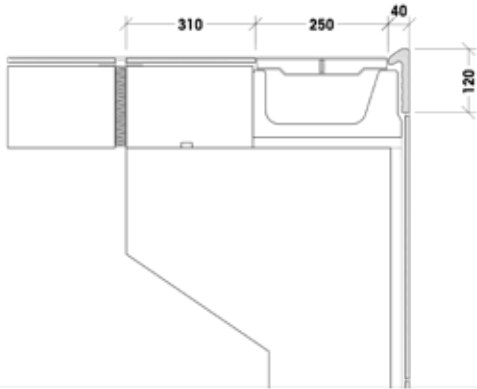

- 01** 244 smooth / anti-slip
Blanco
24,4 x 49,4 cm
Porcelain tile
- 02** 971 anti-slip
Blanco
24,4 x 12 cm
Porcelain tile
- 03** 245 FL anti-slip
Mistry Grey
24,5 x 49,5 x 2,2 cm
Porcelain tile
- 04** 316 anti-slip
Mistry Grey
31 x 62,6 cm
Porcelain tile
- 05** RS 941
S9 System Block
28 x 19 x 12,6 cm

Formats and Finishes

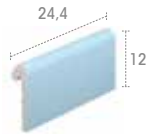
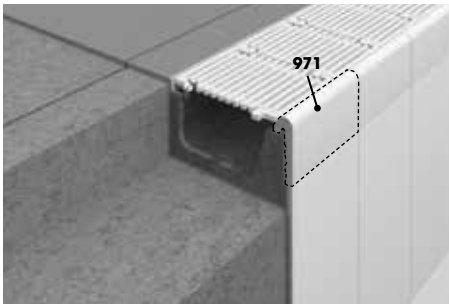

971

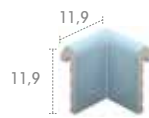
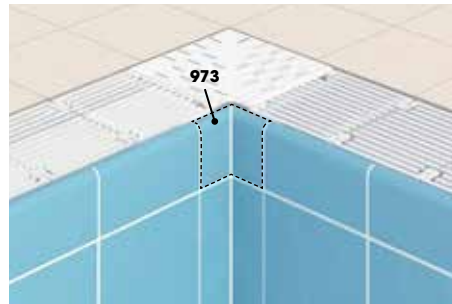

973

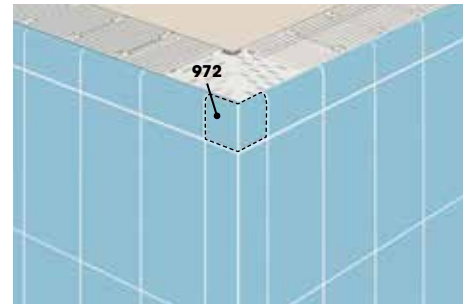

972

anti-slip



Horyzon System

Comprising 2 large format ceramic tiles that form a gentle slope and provide bathers a better grip.

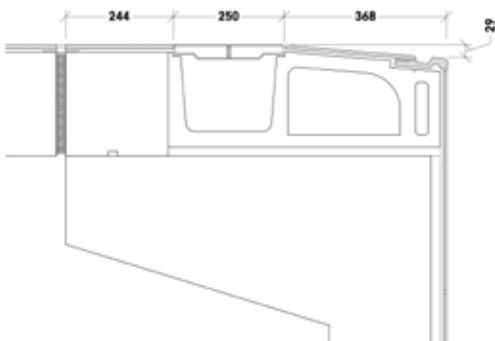
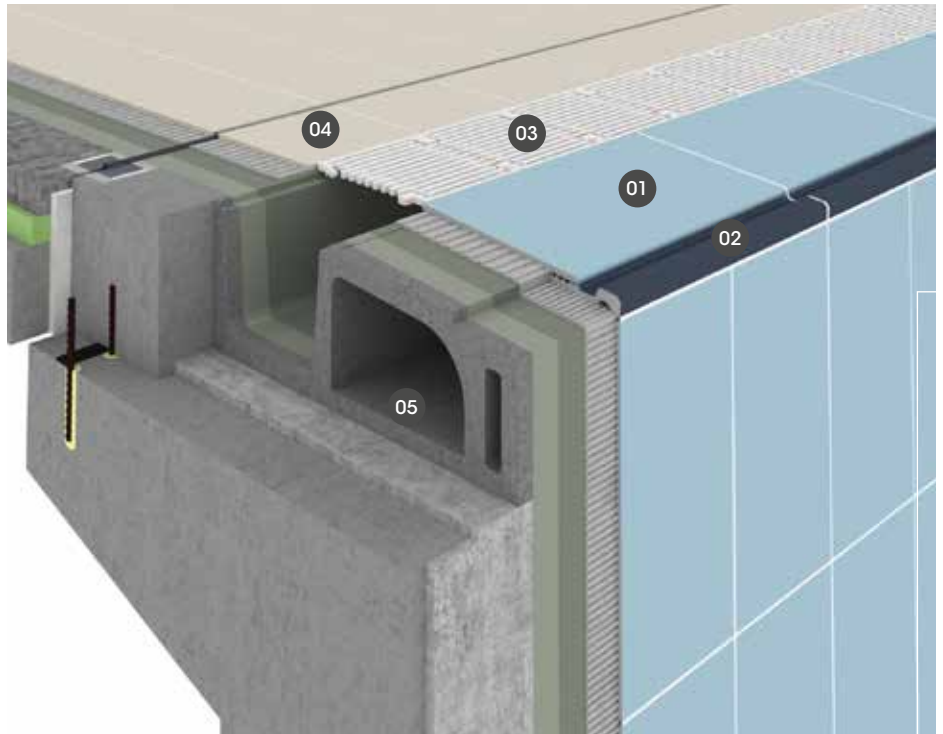

- 01** R49 anti-slip
Azul
49,4 x 29,7 cm
Porcelain tile
- 02** G49 anti-slip
Marino
49,4 x 11,9 x cm
Porcelain tile
- 03** Plastic grid
- 04** 240 pastilla
Indubeige
24,4 x 24,4 cm
Porcelain tile
- 05** RS 911
S9 System Block
61,2 x 19,5 x 21,5 cm

Edging tiles and corners

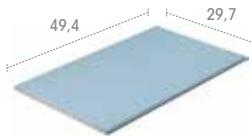
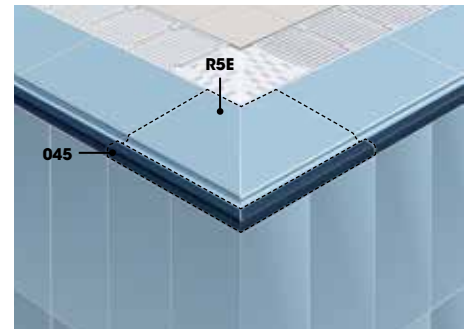
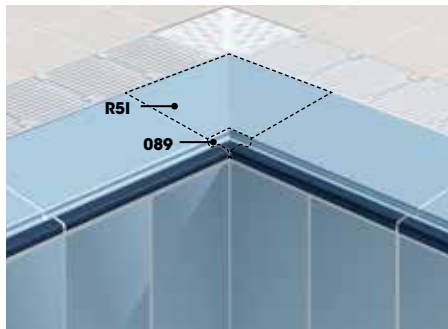
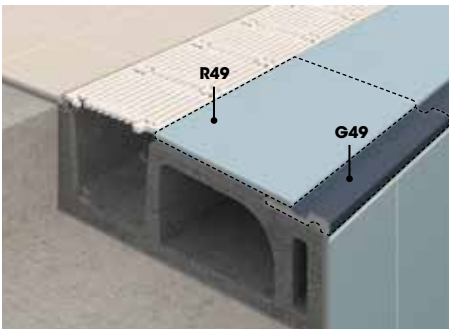

R49

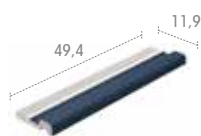

G49

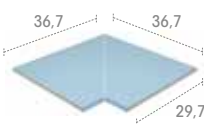

R51

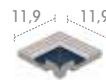

089

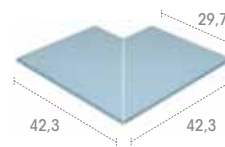

R5E

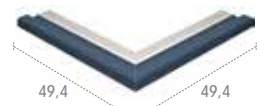

045

anti-slip



Ergo System

A downward-sloping pre-deck system with only two pieces. The edge piece provides the pre-deck slope and acts as a ceramic support for the grid.

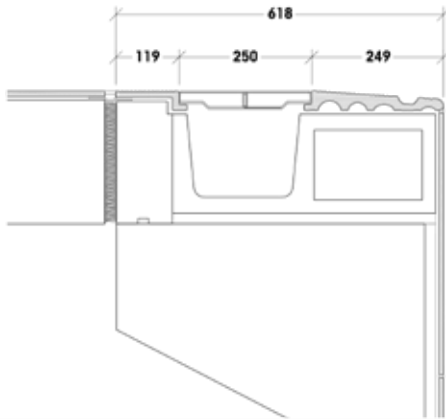
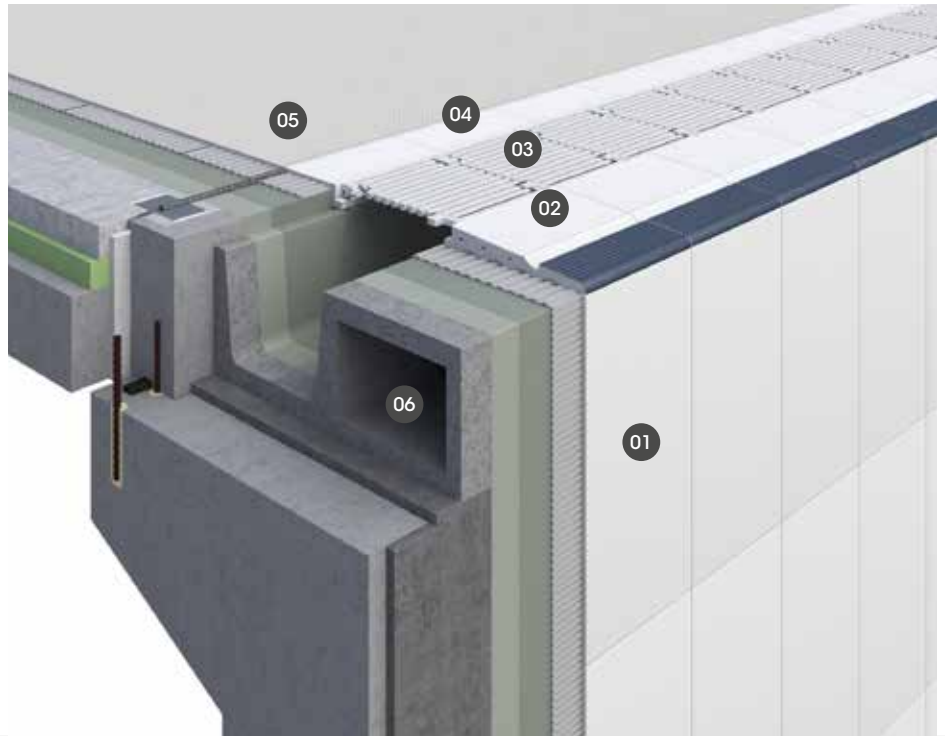

- 01** 244 smooth / anti-slip
Blanco
49,4 x 24,4 cm
Porcelain tile
- 02** 216 anti-slip
Blanco
24,4 x 26,2 cm
Porcelain tile
- 03** Plastic grid
- 04** 035 anti-slip
Blanco
24,4 x 13,4 cm
Porcelain tile
- 05** 240 pastilla
Indubeige
24,4 x 24,4 cm
Porcelain tile
- 06** RS 901
S9 System Block
49,6 x 19,5 x 18,9 cm

Edging tiles and corners

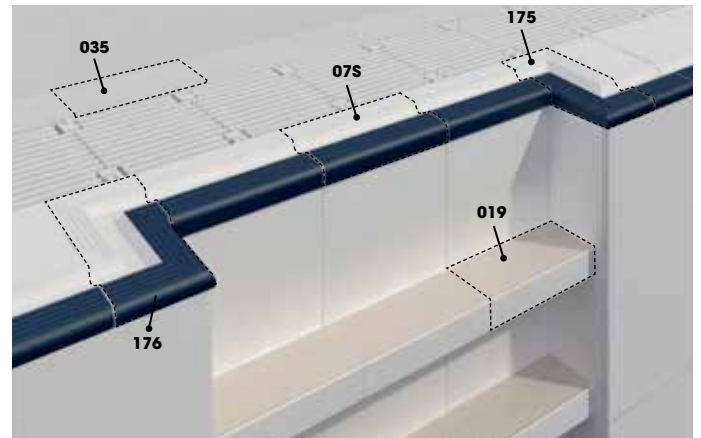
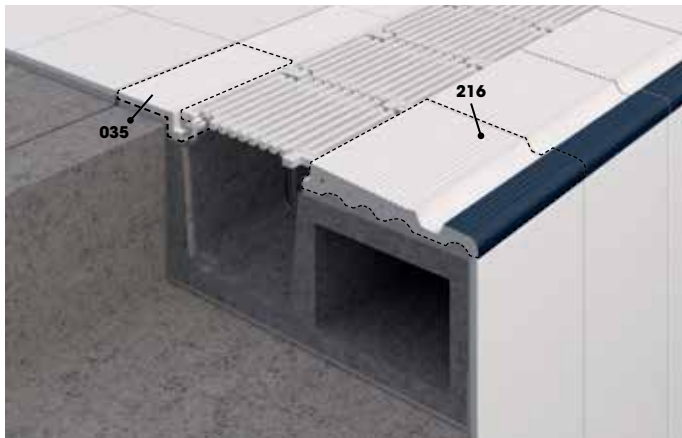

216

044

042

175

176

07S

035

anti-slip



* For black stripes or stripes of any other color, check availability and/or conditions.

Spa System

Created to simplify the construction of deck level pools with mosaic, both public and private. Its main advantages are ease of construction, low cost, speed, reduced space and the vast range of colour combinations.

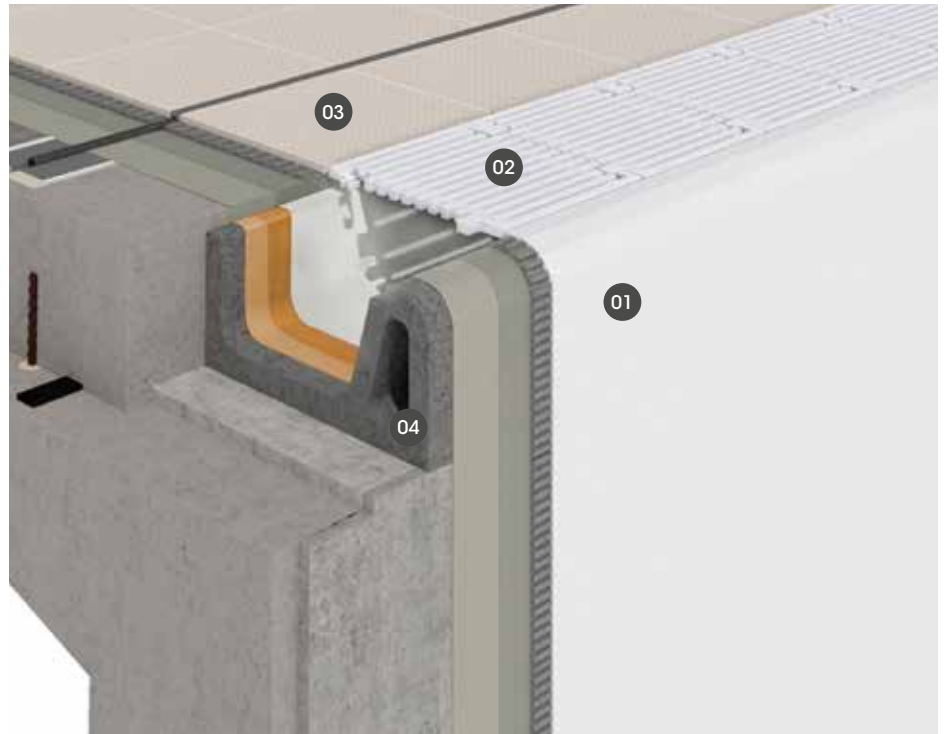
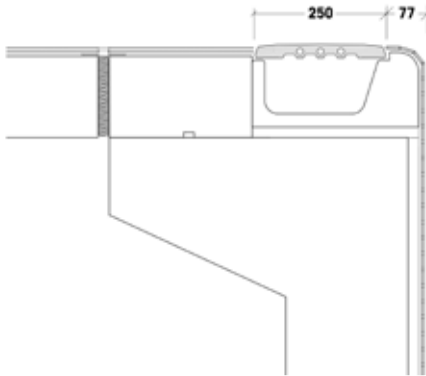

01 **320**
Mosaic Blanco
33 x 33 cm
Glass mosaic

02 Plastic grid

03 **240 pastilla**
Indubeige
24,4 x 24,4 cm
Porcelain tile

04 **RS 931**
S9 System Block
31,4 x 19 x 12,7 cm

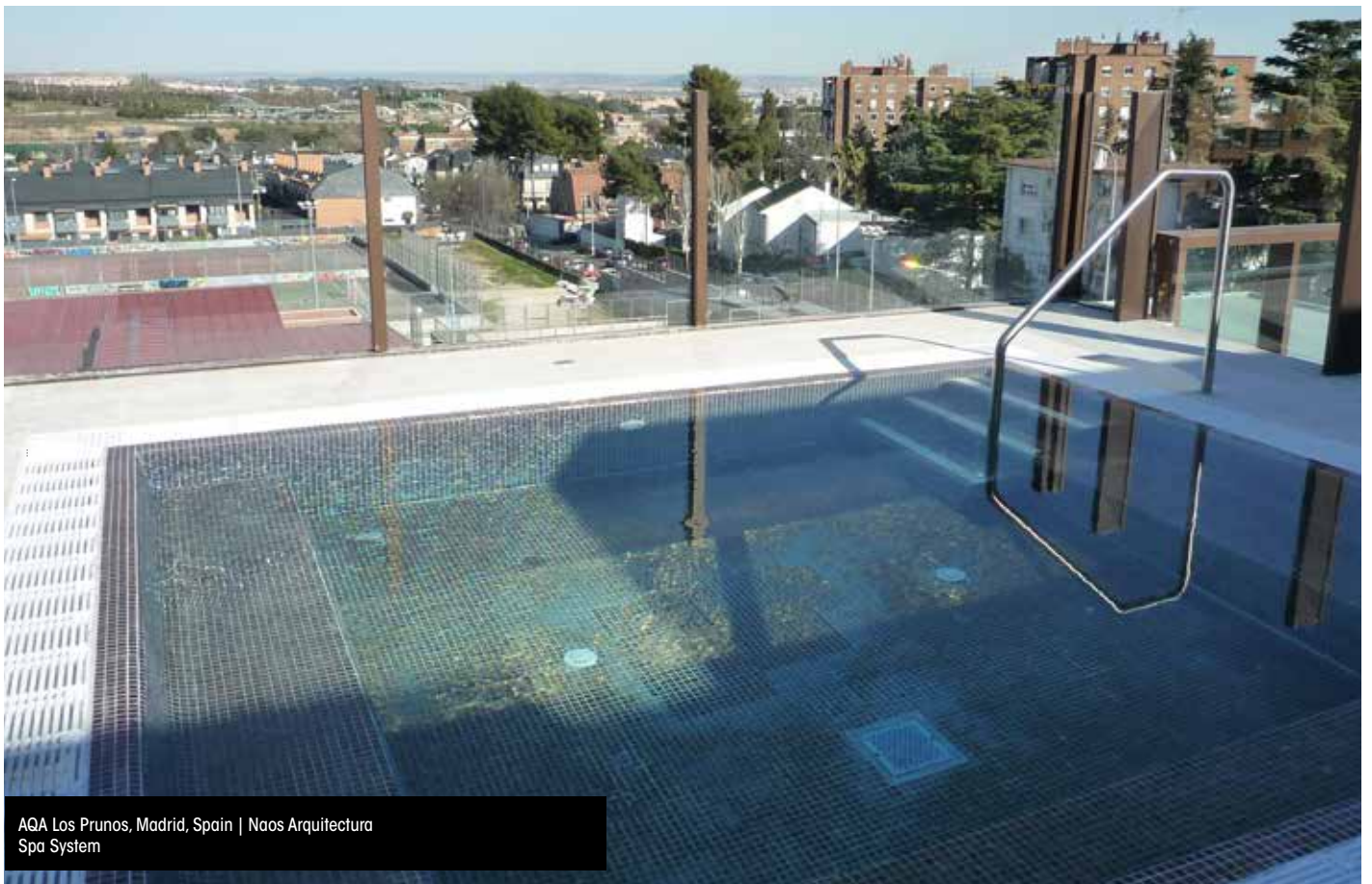

AQA Los Prunos, Madrid, Spain | Naos Arquitectura
Spa System

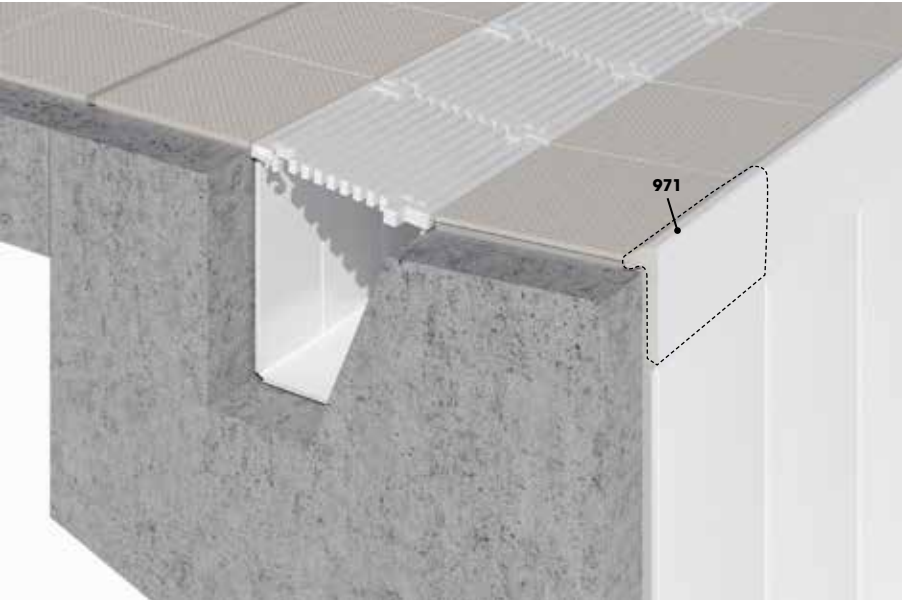

Zurich System

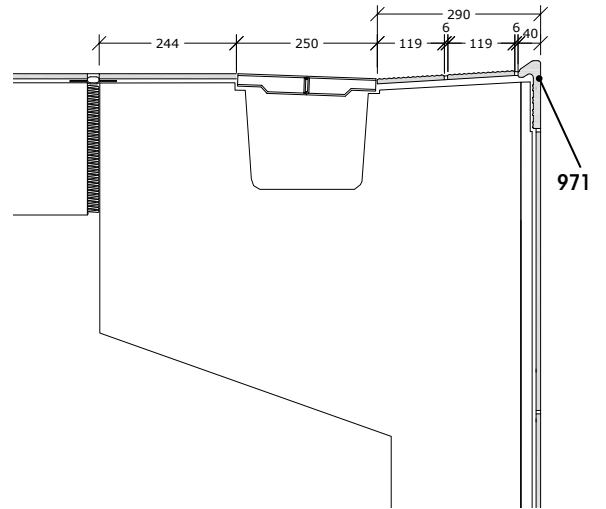

Edging tiles and corners

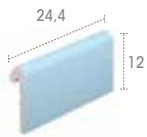

971
anti-slip

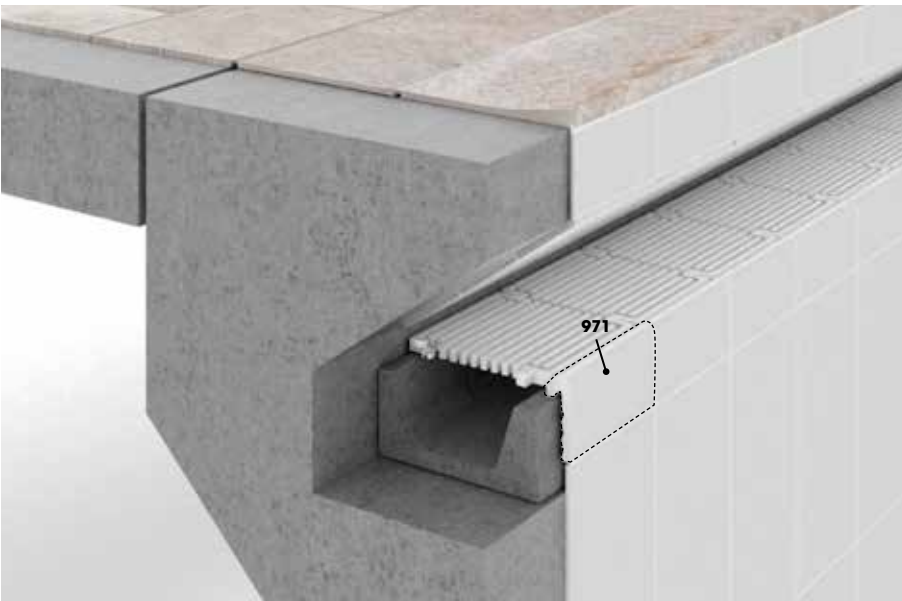

Wiesbaden B System

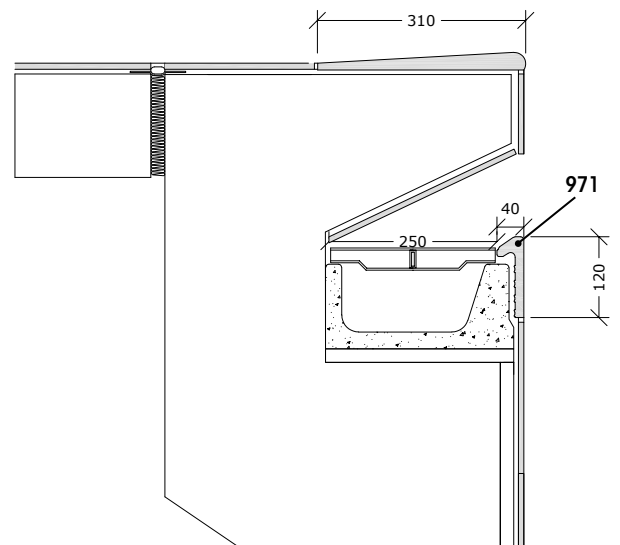

Edging tiles and corners

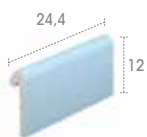

971
anti-slip



Aqua

Colors

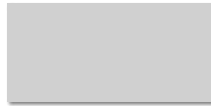

244 G1
smooth / anti-slip
24,4 x 49,4 x 0,8



122 G1
smooth / anti-slip
11,9 x 24,4 x 0,8



052 G1
smooth
5,6 x 24,4 x 0,8

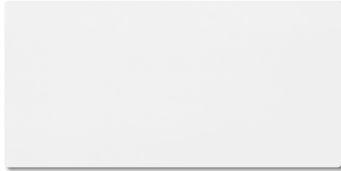

Blanco

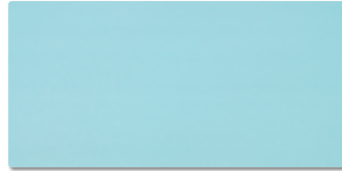

Azul

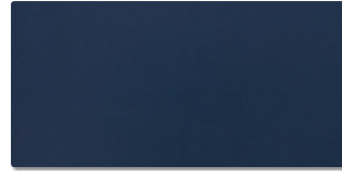

Marino



Prusia

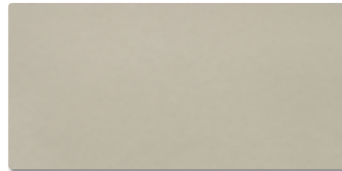

Habana



Oliva



Rojo N



Amarillo



Plomo



Arlozorov 97 Sports Center | Tel Aviv, Israel | Mayslits Kassif Roytman Architects
Horizon System

Mosaic

Colors



Blanco

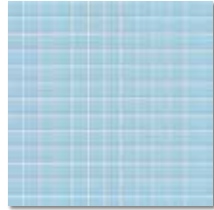

Azul



320
smooth / anti-slip
33 x 33 x 0,5

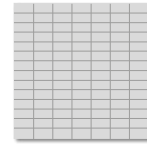

323
smooth / anti-slip
33 x 33 x 0,5

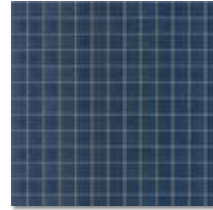

Marino

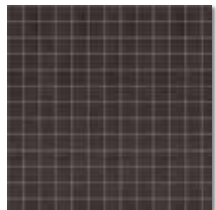

Plomo

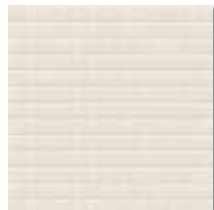

Ivory

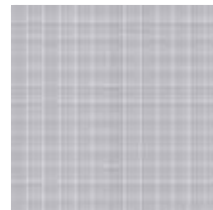

Perla

* Glass mosaic

Aqua & Mosaic

Matching colors



Blanco



Azul



Marino



Plomo



Vals Sport Teatinos | Málaga, Spain
Horizon System

Half-round pieces

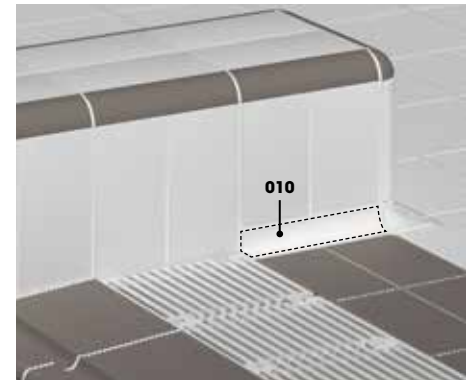
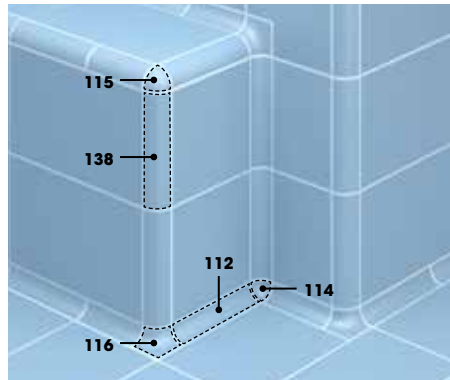
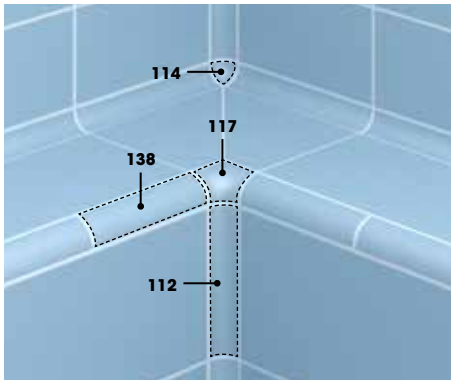

138

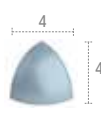

115

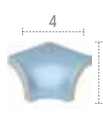

117



112

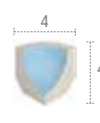

114

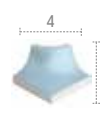

116

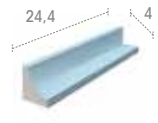

010

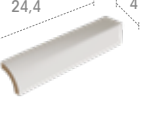

020

smooth



Blanco



Marino



Azul

anti-slip



Blanco



Marino



Azul



Plomo



Indubeige

anti-slip



Blanco



Plomo



Marino



Azul



Indubeige

smooth



Blanco



Plomo



Azul



Azul



Indubeige



Marino



Plomo



Indubeige

smooth



Blanco



Azul

Bullnose

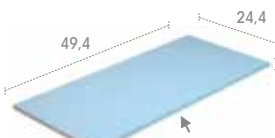
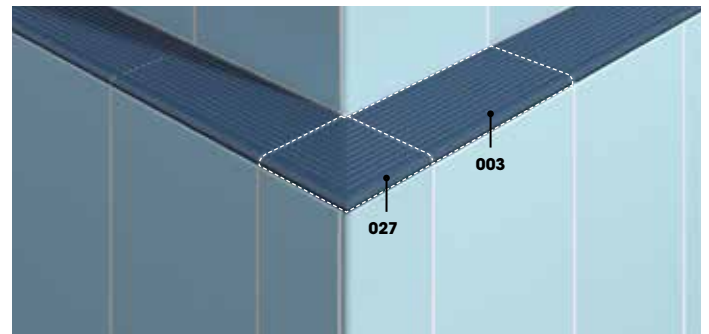
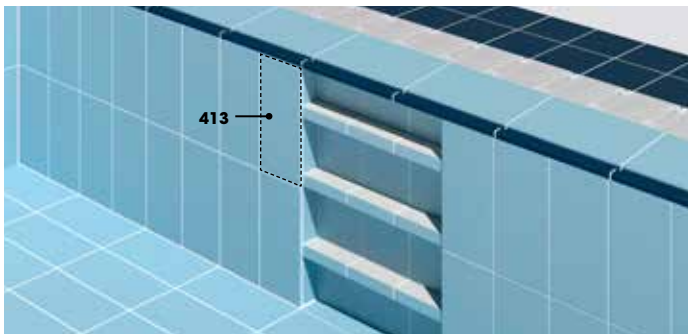

413

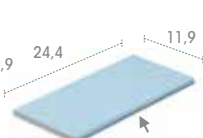

013

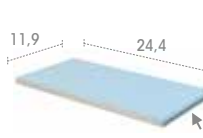

009

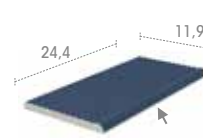

003



027

smooth



Blanco



Marino



Azul



Plomo

smooth / anti-slip



Blanco



Marino



Indubeige



Azul



Plomo

smooth / anti-slip



Blanco



Azul

anti-slip



Blanco



Marino



Azul



Indubeige

anti-slip



Marino

↗ Bullnose

Grooved tiles

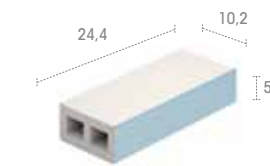
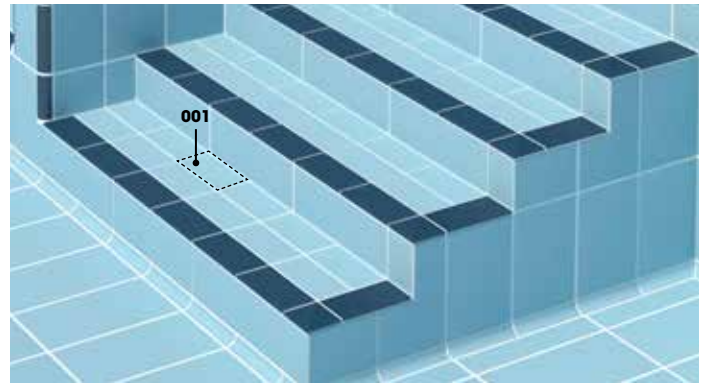
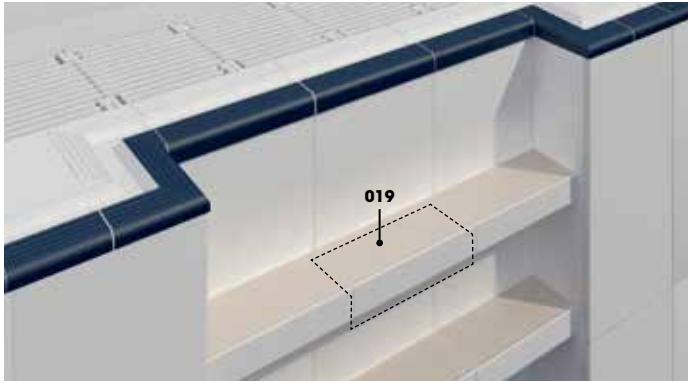

019

anti-slip

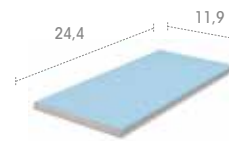
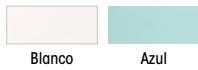

001

anti-slip



Depth tiles



122 N9



122 P9

smooth / anti-slip

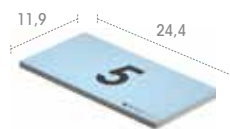
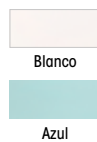

122 PO/122 P8

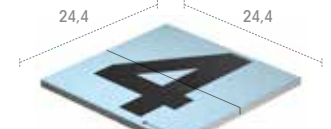

C01 / C08

smooth

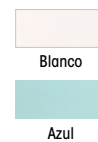

Indugres

100% Biostop Finish

CERAMIC TILE THAT ELIMINATES BACTERIA

THE ONLY TOTAL SELF-PROTECTION SOLUTION:
PORCELAIN CERAMIC TILE AND SEALING GROUT

Wall tiles

244 G1 smooth
24,4 x 49,4 x 0,8

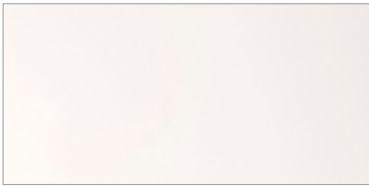

Bio White

Floor tiles

240 G3
24,4 x 24,4 x 1



Indubeige R10



Indubeige R11



Indu Grey R10

Sealing grout



BIO-CERPOXI WHITE / 22,5 KG/U
BIO-CERPOXI GREY / 21 KG/U

Coloured epoxy resin resistant to acid and with protective properties: prevents the growth of harmful microorganisms.

Biostop (tiles and grout) complies with the ASTM E 2149, JIS Z 2801 Antimicrobial efficiency regulation and ISO-22196.

Why choose Biostop?



IT WORKS 24/7: INSIDE AND OUTSIDE

Biostop does not need light to activate its self-protection properties: it works with artificial light, natural light and even in complete darkness.



COMPLETE AND PERMANENT PROTECTION

Biostop's protection is permanent and 100% safe. It doesn't require any subsequent treatment or maintenance to have an effect.



PROVED EFFECTIVE AGAINST BACTERIA

Biostop completely stops the spread of bacteria such as Staphylococcus aureus, Escherichia coli, Proteus vulgaris, Salmonella Typhi, Enterococcus faecalis, Streptococcus pyogenes, Bacillus and Listeria monocytogenes.



HIGH-QUALITY INDUSTRIAL PORCELAIN STONEWARE

The manufacturing process behind Biostop ensures it retains all the properties usually associated with Rosa Gres industrial porcelain stoneware.



IT IS NOT HARMFUL TO HEALTH

Biostop is non-toxic.
It is completely harmless to human health.



IT REDUCES SMELLS

Biostop prevents bad smells that can be caused by micro-organism deposits on the surface.

Indugres 100% Biostop Finish

Half-round pieces

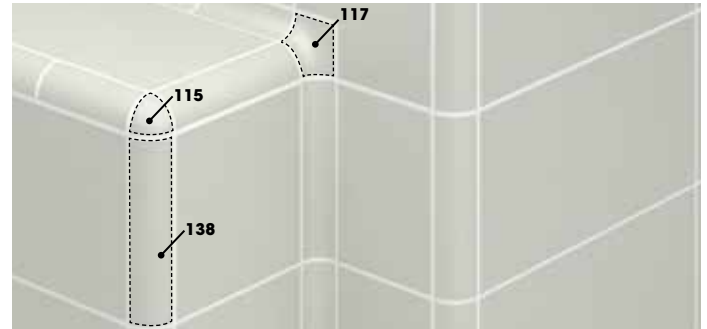
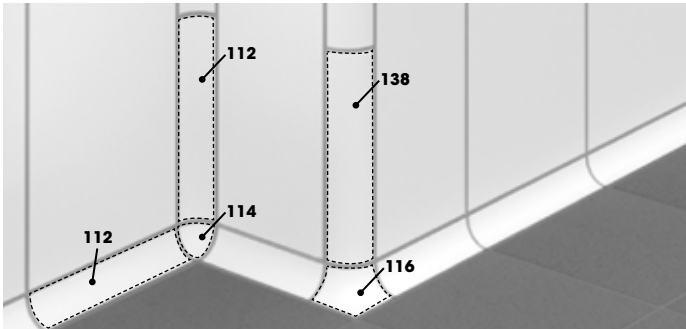

112



114

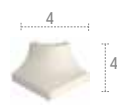

116



138



115



117

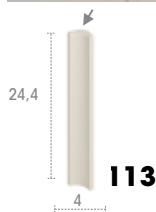
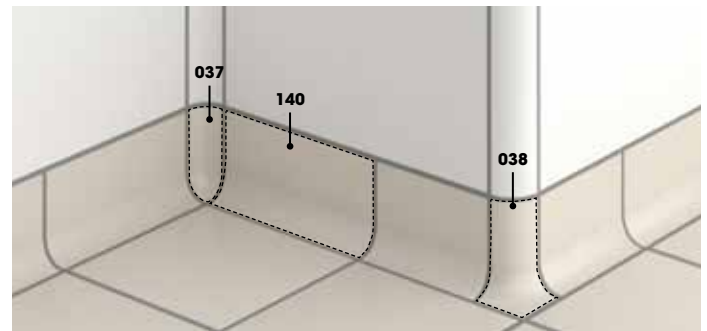
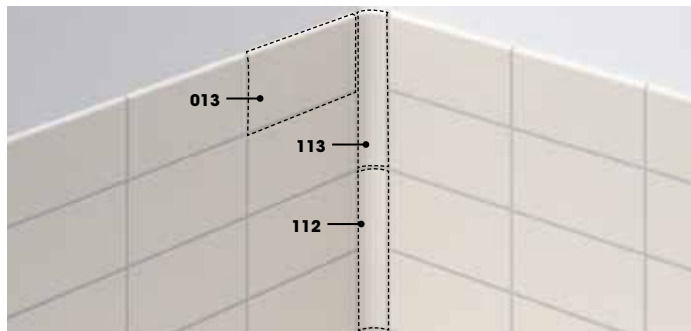

113

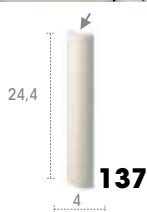

137



013



140



037

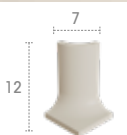

038



▶ Bullnose

Grooved tiles

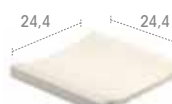
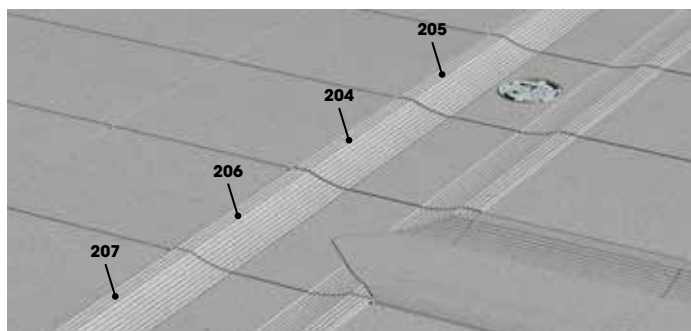

204



205



206



207

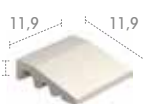

130

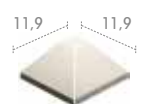

136



131



Colors



Plomo Pastilla



Indubeige Pastilla

Waterways

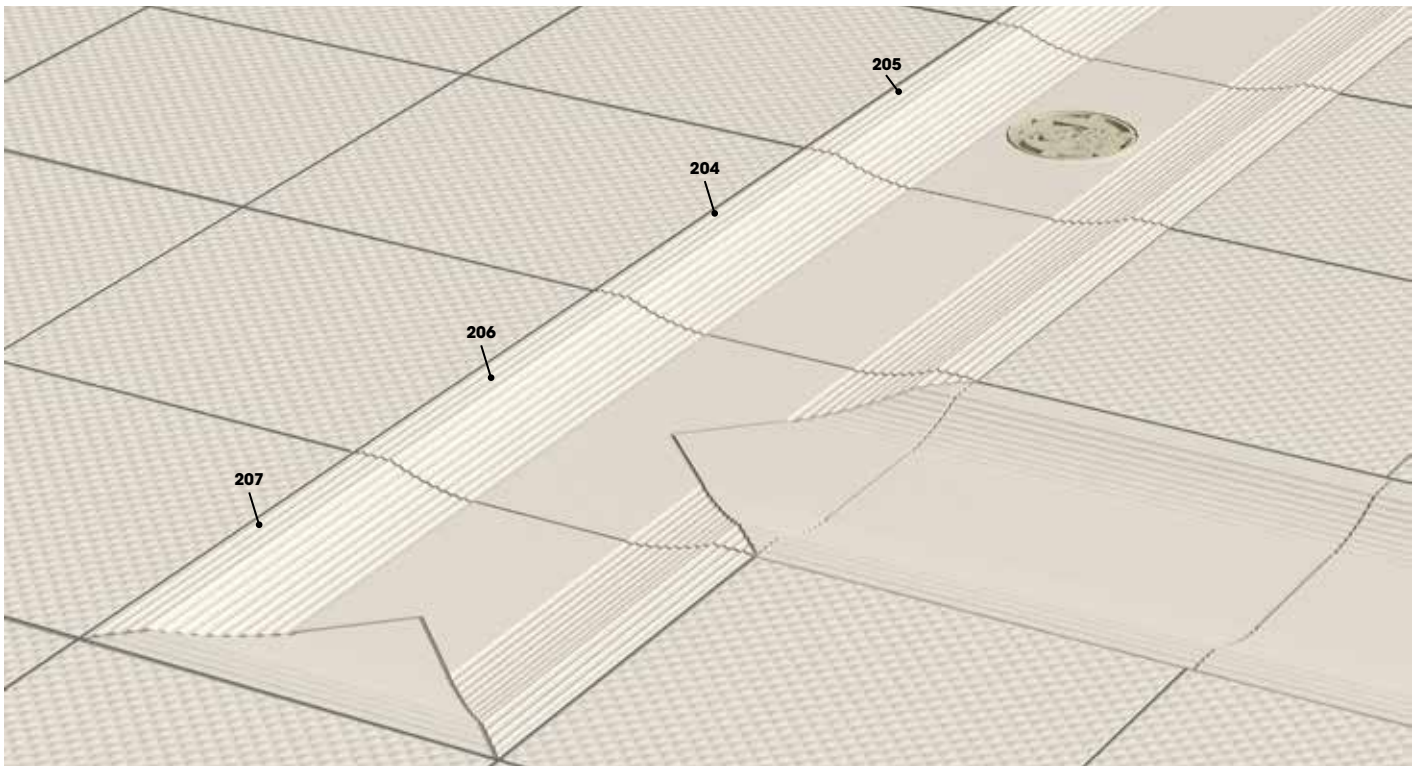

204

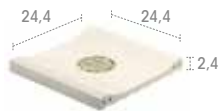

205



206



207

anti-slip





**CLUB ESPORTIU PUTXET
BARCELONA, SPAIN**



trésor



Trésor Bali



Trésor Java

stela *mix*



Stela White



Stela Golden



Stela Grey



Stela Dark

pietro *mix*



Pietro White



Pietro Golden



Pietro Grey



Pietro Dark

Formats Trésor



316 anti-slip
31 x 62,6 x 0,9



310 BH anti-slip
31,3 x 31,3

Mesh-mounted porcelain stoneware mosaic tiles

Formats Stela



199 smooth/anti-slip
19,41 x 97,9 x 1

Formats Pietro



316 anti-slip
31 x 62,6 x 0,9



490 anti-slip
48,8 x 48,8 x 1



50M anti-slip
48,8 x 97,9 x 1

alma



Alma Mist



Alma Forest



Alma Honey



Alma Pure

serena



Serena Bianco



Serena Ocra



Serena Griggio



Serena Nero



Serena Mix *

* Available in 31 x 62,6 x 0,9

mistry



Mistry White



Mistry Sand



Mistry Grey



Mistry Blue Stone

Formats **Alma**



199 smooth / anti-slip
19,41 x 97,9 x 1

Formats **Serena**



316 anti-slip
31 x 62,6 x 0,9



490 anti-slip
48,8 x 48,8 x 1

Formats **Mistry**



316 smooth / anti-slip
31 x 62,6 x 0,9











50M smooth / anti-slip
48,8 x 97,9 x 1



310 BH anti-slip
31,3 x 31,3

Mesh-mounted porcelain stoneware mosaic tiles

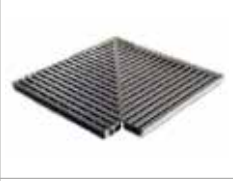
Grating

	GRATING Blanco		90° CORNER PLASTIC PIECE Blanco		LONGITUDINAL GRATE Blanco
245 R2 24,5 x 19,5 x 2,2 295 R2 29,5 x 19,5 x 2,2 335 R2 33,5 x 19,5 x 2,2		195 E2 19,5 x 19,5 x 2,2 245 E2 24,5 x 24,5 x 2,2 295 E2 29,5 x 29,5 x 2,2 335 E2 33,5 x 33,5 x 2,2	195 E3 20 x 20 x 3,5 245 E3 25 x 25 x 3,5 295 E3 30 x 30 x 3,5 335 E3 34 x 34 x 3,5	195 L2 19,5 x 20,6 x 2,4 245 L2 24,5 x 20,6 x 2,4 295 L2 29,5 x 20,6 x 2,4 345 L2 34,5 x 20,6 x 2,4	
	END PIECE FOR LONGITUDINAL GRATING Blanco		MODULAR GRATE FOR BENDS Blanco		GRATING SUPPORT PROFILE (1) Blanco
195 TO 19,5 x 2,4 245 TO 24,5 x 2,4 295 TO 29,5 x 2,4 345 TO 34,5 x 2,4		195 V2 19,5 x 2,2 245 V2 24,5 x 2,2 295 V2 29,5 x 2,2 335 V2 33,5 x 2,2	195 V3 19,5 x 3,5 245 V3 24,5 x 3,5 295 V3 29,5 x 3,5 335 V3 33,5 x 3,5	243 PF 2,4 x 3,7 x 200	
	GRATING (2) Plomo		90° CORNER PLASTIC PIECE Plomo		LONGITUDINAL GRATE Plomo
245 R2 24,5 x 250 x 2,4		245 E2 24,5 x 24,5 x 2,4		245 L2 24,5 x 100 x 2,4	
	MODULAR GRATE FOR BENDS Plomo				
245 V2 2,5 x 250 x 2,4					

Cork floats line

	CORK FLOATS LINE (3)		SLOPING ANCHORAGE		FLAT ANCHORAGE
ROMM2 25 ROMM5 50		ANIH1 Ø43 Tube ANIH2 Ø48 Tube		ANPH1 Ø43 Tube ANPH2 Ø48 Tube	
	CORK FLOATS HOLDER		ANCHOR CUP		SCREW ANCHOR
SPCH1 Ø43 Anchorage		CAE00 Retractable anchor		ANTH1 Ø43 Tube	

(1) 2 units required to hold the grid. Sold in units of 2 m





(2) Sold in units of 2'5 m

(3) Stairs with customized porcelain stoneware steps

(4) Anchorages not included

(5) Podium numbers not included

Stairs

	STAIR WITH HANDRAIL MODEL 1000		MODEL SPLIT STAIRS		STAIR WITH HANDRAIL ERGO MODEL
MILX3 3 Steps	MILX4 4 Steps	PTDX3 3 Steps	PTDX4 4 Steps	EPEZ3 3 Steps	EPEZ4 4 Steps
	ASYMMETRIC STAIR		EXTERNAL / INTERNAL HOLDER EXITS		
SMA00	2 Handrail 1000	PAS00	043 Steel Inox		

Signs

	FALSE START SIGNALING FOR POLES ⁽⁴⁾		SWIMMERS' START PODIUM ⁽⁵⁾		SIGNAL FLAGS ⁽⁴⁾
SS FH 1 Ø43 Poles SS FH 2 Ø48 Poles	SS FFC Polyester rope	PDAH7 70 cm high - blue		BDNH1 Ø43 Poles BDNH2 Ø48 Poles	BDNHBC 2 Strings and signal flags
	LIFE PRESERVER		HYDRAULIC ELEVATOR		LIFE PRESERVER SUPPORT
SAL PL Plastic	SAL LN Canvas	ELVML Handrail 1000	ELV65 Handrail 650	SSV00	PSV00 LIFE PRESERVER STAND SUPPORT

Other options





	POLYPROPYLENE ANCHORAGE		PVC DRAINS		DRAIN SILENCER		PP HOMOPOLYMER
ANEH1		990				EMB 00	

TESTING REGULATIONS	REGULATION EN 14411	Trésor / Stela Pietro / Alma Serena / Mistery	Aqua	Indugres	Mosaic
----------------------------	--------------------------------	--	-------------	-----------------	---------------

DIMENSIONS AND SURFACE QUALITY

 ISO 10545-2	Dimensions and surface quality	Required	Guaranteed	Guaranteed	Guaranteed	Guaranteed
---	--------------------------------	----------	------------	------------	------------	------------

PHYSICAL PROPERTIES

 ISO 10545-3	Water absorption	Group A1a E < 0,5 %	Group B1a E < 0,5 %	E < 0,5 %	E < 0,5 %	E < 0,5 %	E < 0,5 %
 ISO 10545-4	Modulus of rupture	Group A1a > 28 N/mm ²	Group B1a > 35 N/mm ²	> 40 N/mm ²	> 40 N/mm ²	> 40 N/mm ²	-
 ISO 10545-6	Resistance to deep abrasion	< 175 mm ³	-	-	-	< 175 mm ³	-
 ISO 10545-9	Thermal shock resistance	Required	Guaranteed	Guaranteed	Guaranteed	Guaranteed	-
 ISO 10545-12	Frost resistance	Required	Guaranteed	Guaranteed	Guaranteed	Guaranteed	Guaranteed

CHEMICAL PROPERTIES

 ISO 10545-13	Chemical resistance ⁽¹⁾	Min. Class B	A / LA / HA	A / LA / HA	A / LA / HA	A / LA / HA	A / LA / HA
 ISO 10545-14	Stain resistance	Min. Class 3	Guaranteed	Guaranteed	Guaranteed	Guaranteed	Guaranteed

(1) Except hydrofluoric acid and its components

Base pieces:

Group B1a pressed porcelain tiles

Trim pieces:

Group A1a extruded porcelain tiles

Minimum joint (Field tiles)

A minimum joint of 3 mm is recommended for the following formats: 48,8 x 48,8 cm and 48,8 x 97,9 cm.

When it's necessary to modulate field tiles with trim pieces, the joint should be 6 mm.

* Biostop (tiles and grout) complies with the ASTM E 2149, JIS Z 2801 Antimicrobial efficiency regulation and ISO-22196.

ANTI-SLIP COEFFICIENTS

		UNE 41901			DIN 51130 XP P-05-010			DIN 51097 XP P-05-010		ANSI A137.1
		Class 1	Class 2	Class 3	R9 / PC6	R10 / PC10	R11 / PC20	Class B / PN18	Class C / PN 24	> 0.42
trésor	anti-slip			●		●			●	
stela	smooth	●			●					
	anti-slip			●			●		●	●
pietro	anti-slip			●			●		●	●
serena	anti-slip			●			●		●	●
alma	smooth	●			●					●
	anti-slip			●			●		●	●
mystery	smooth	●			●					
	anti-slip			●			●		●	●
aqua	pastilla anti-slip Tank			●					●	
mosaic	anti-slip			●					●	
Indugres	Indubeige R10		●			●		●		●
	Indu Grey R10		●			●		●		
	Indubeige R11			●			●	●		

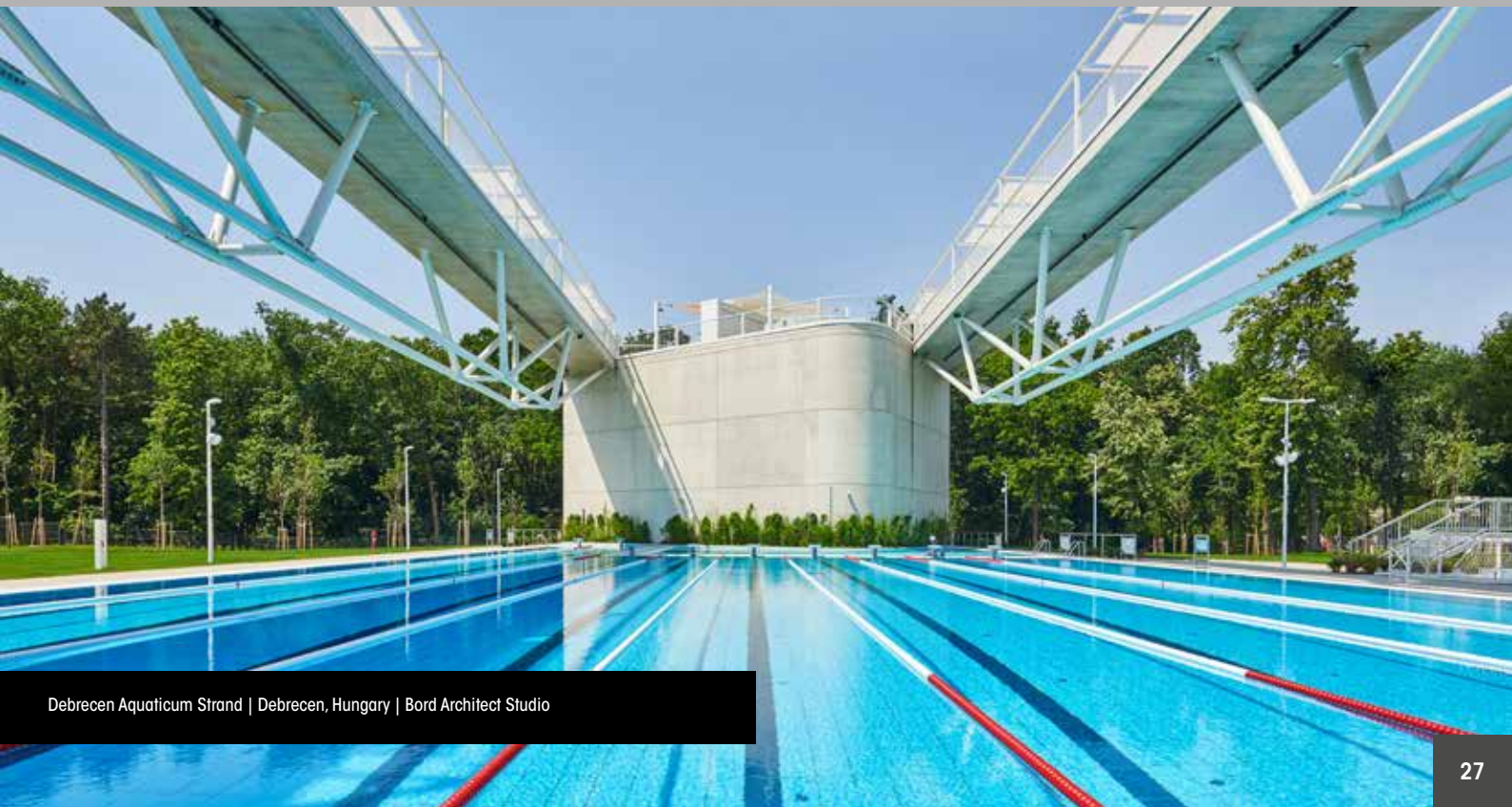



Back cover: Centro Acuático Tehuacán | México | Arq. Gabriel Armendáriz | Horyzon System



Rosa Gres, SLU

Central office

Ctra. Sant Cugat, km. 3
08290 Cerdanyola, Barcelona, Spain
Tel. + 34 93 586 30 60
Export Sales: + 34 93 586 37 02
info@rosagres.com
www.rosagres.com

Rosa Gres France, SARL

66, Chemin Mirassou
64140 Lons, France
Tel. + 33 04 11 92 00 30
contact@rosagres.com
administration@rosagres.com
www.rosagres.com/fr

Factory

Pol. Ind. Mas Vell
Ramón Sugrañes, 1
43144 Vallmoll, Tarragona, Spain

September 2021

