

Unique pools



ROSA
GRES

PRICE LIST 2026 JANUARY

ENGLISH



Skimmer Pool

S Solution	3
L Solution	3
New Look System	4

Zen System

5

Solution for Infinity Pools

5

Half-round pieces and Shallow channel

5

Deck-level pool Colors

Minimal System	6
Ergo Plus System with Compact Grid	8
Prestige System with Flex Grid	9
Smart System	10
Slim System	11

Colors Rosa Gres

12

Packing

13

Fixcer installation products - Zero Problems Pools

Construction joints, sealing for PVC tubes and mortar	18
Cement-based waterproofing systems	19
Grouting	20
System 9 and Expansion Joint	21
Pool Decks	22
Cleaners and tools	23

SKIMMER POOL | S SOLUTION



S62	S13	183	188	DS1
				
62,6 x 31 x 2,6	46 x 46 x 2,6	31 x 4 x 4	31 x 4 x 4	31 x 31 x 2,6
€/PIECE	€/PIECE	€/PIECE	€/PIECE	€/PIECE
40,21 €	98,81 €	6,59 €	6,59 €	122,31 €

SKIMMER POOL | L SOLUTION



L98	E98	L62	E62	DL1	DL2
					
97,9 x 31,7 x 3,8	97,9 x 97,9	62,6 x 31,7 x 3,8	62,6 x 62,6 x 3,8	31,7 x 31,7 x 3,8	31,7 x 31,7 x 3,8
€/PIECE	€/PIECE	€/PIECE	€/PIECE	€/PIECE	€/PIECE
68,25 €	268,11 €	41,49 €	141,12 €	98,81 €	58,81 €

SKIMMER POOL / NEW LOOK SYSTEM



BR6	ER6	BR9	ER9
			
62,6 x 50 x 2,6	62,6 x 62,6 x 2,6	97,9 x 50 x 2,6	97,9 x 97,9 x 2,6
€/PIECE	€/PIECE	€/PIECE	€/PIECE
70,30 €	218,00 €	110,53 €	268,11 €

PIECES FOR CURVED TANK AND WALL FINISHES



056	E56
	 
62,6 x 5 x 0,9	5 x 4,3 x 0,9
€/PIECE	60 UNITS / BOX
2,15 €	218,00 €

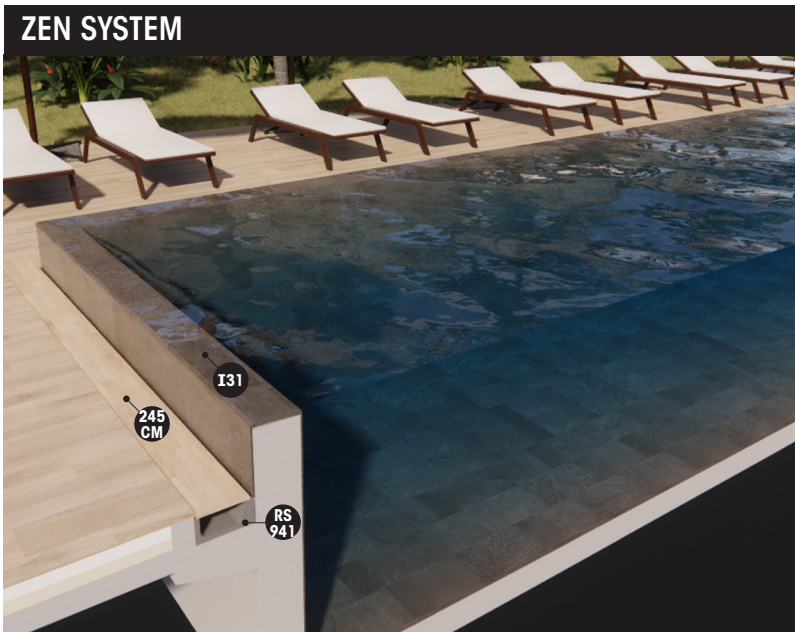



RS 941	245 CM	I31
		
28 x 19 x 12,6	62,6 x 24,5 x 2,2	62,6 x 31 x 2,6
€/PIECE	€/PIECE	€/PIECE
12,62 €	115,24 €	70,30 €

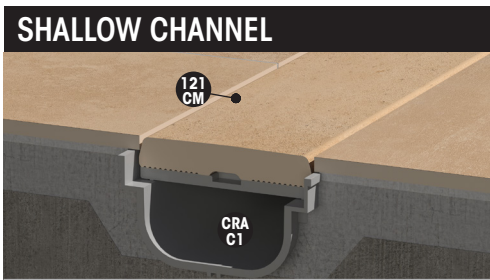

I31	EI3
	
62,6 x 31 x 2,6	62,6 x 62,6 x 2,6
€/PIECE	€/PIECE
70,30 €	141,12 €



121 CM	CRA C1
	
62,6 x 12,5 x 2,2	50 x 13 x 7,5
€/PIECE	€/PIECE
98,81 €	20,00 €

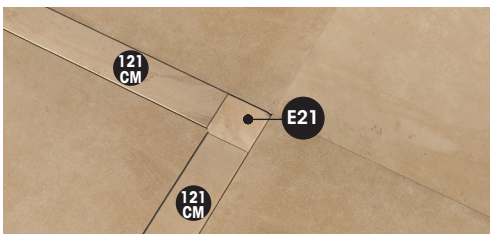

TCR C1	E21	CCR C1	DCR C1
			
-	125x125x2,2	-	-
€/PIECE	€/PIECE	€/PIECE	€/PIECE
5,19 €	40,21 €	20,00 €	5,19 €

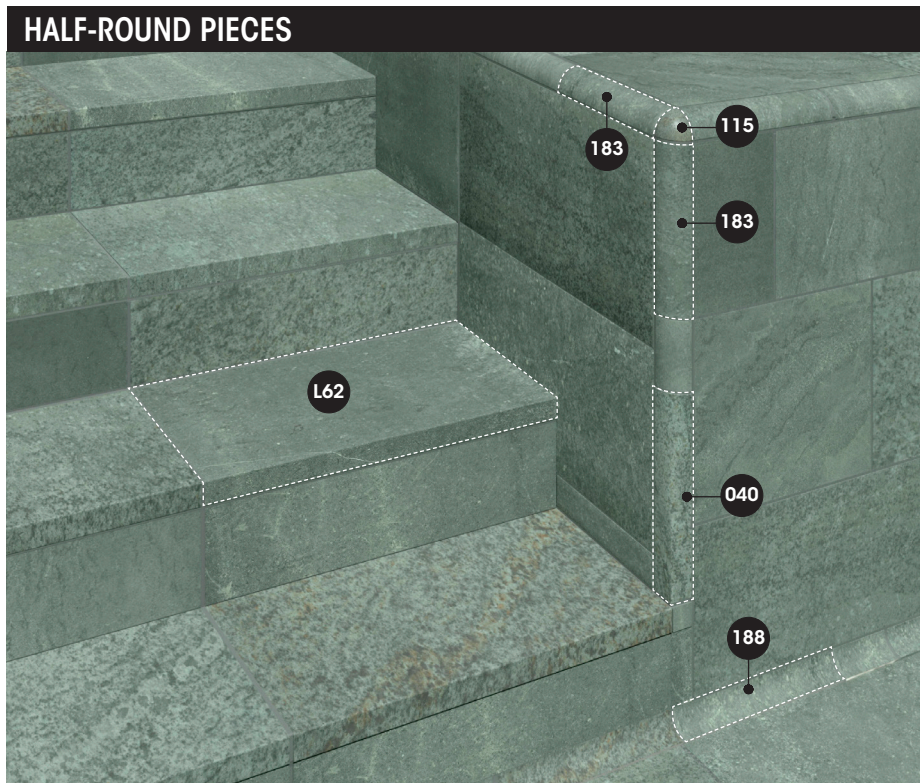

183	115	117	188	114	116	030	040
							
31 x 4 x 4	4 x 4	4 x 4	31 x 4 x 4	4 x 4	4 x 4	Interior half-round piece ending in a right angle 31 x 4 x 4	Exterior half-round piece ending in a right angle 31 x 4 x 4
€/PIECE	€/PIECE	€/PIECE	€/PIECE	€/PIECE	€/PIECE	€/PIECE	€/PIECE
6,59 €	22,94 €	34,15 €	6,59 €	22,94 €	34,15 €	47,10 €	47,10 €

DECK-LEVEL POOL / MINIMAL SYSTEM WITH BR6/BR9

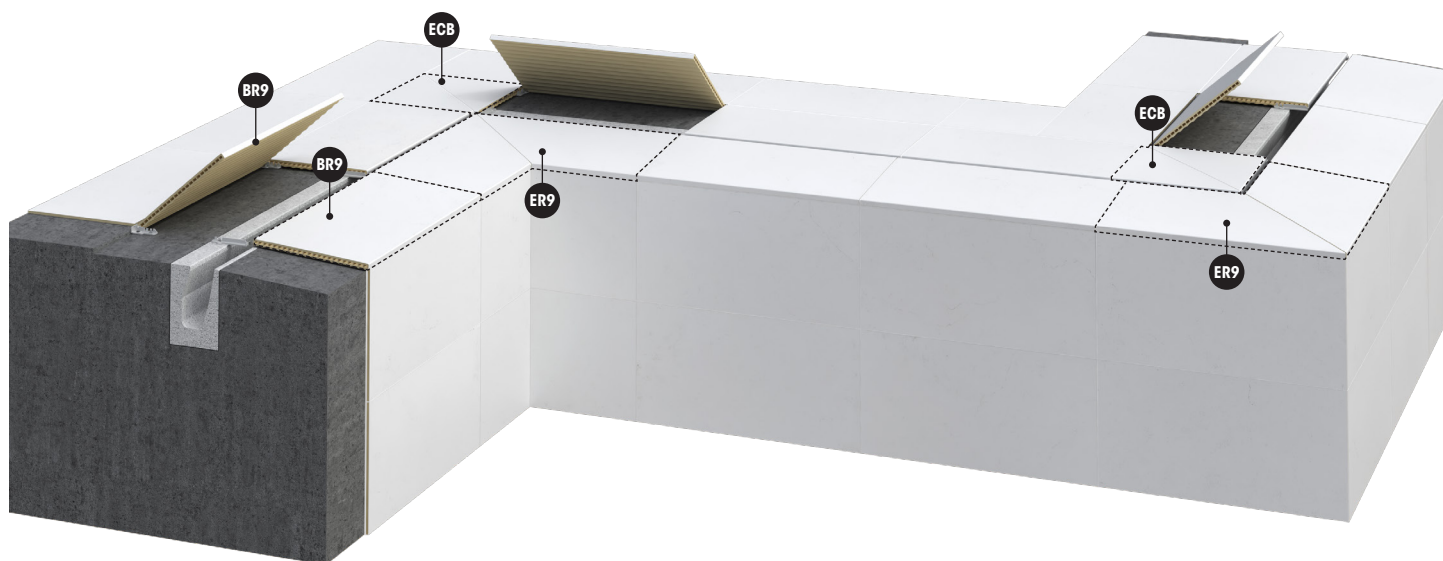

BR6	ER6	BR9	ER9	ECB
				
62,6 x 50 x 2,6	62,6 x 62,6 x 2,6	97,9 x 50 x 2,6	97,9 x 97,9 x 2,6	52,8 x 52,8 x 2,6
€/PIECE	€/PIECE	€/PIECE	€/PIECE	€/PIECE
70,30 €	218,00 €	110,53 €	268,11 €	268,11 €

DECK-LEVEL POOL / MINIMAL SYSTEM / S9 BLOCKS *

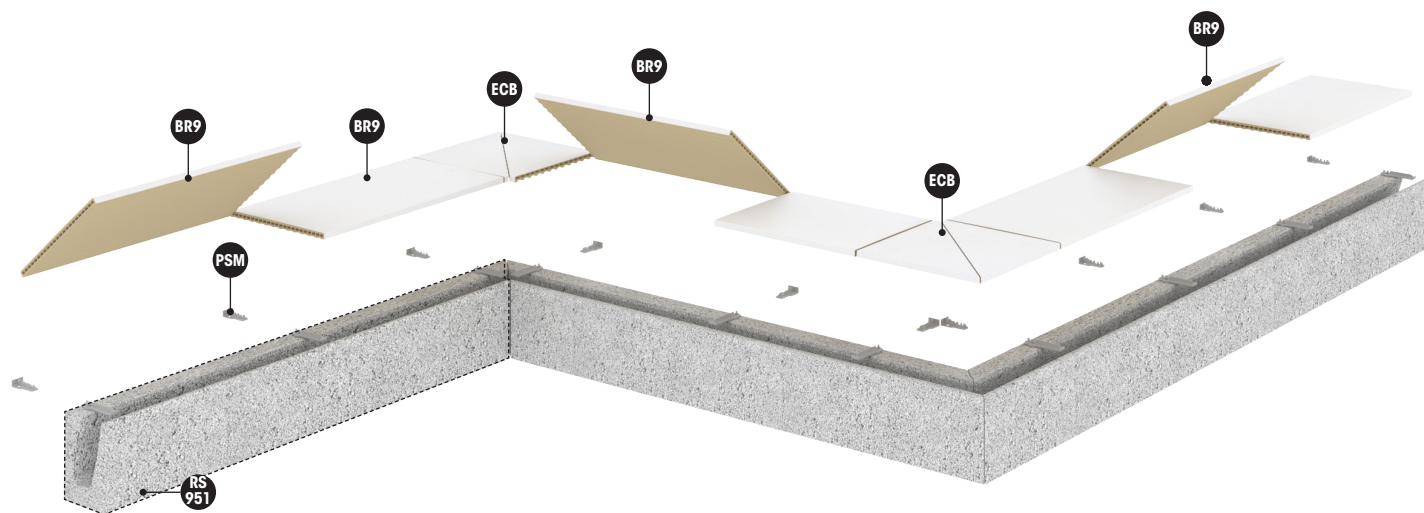

RS 951
Base

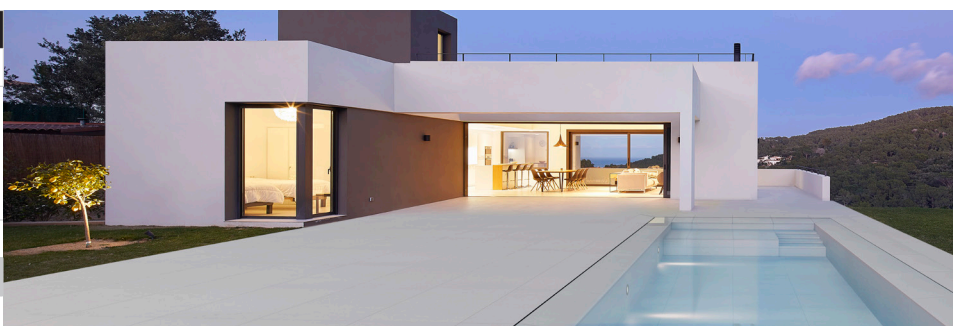
29,7 x 19,5 x 20,8
€/PIECE
12,62 €



The S9 blocks are exclusively made with Rosa Gres ceramic tiles

DECK-LEVEL POOL / MINIMAL SYSTEM WITH 647



I31	ECI	647	664	E65	665	183
62,6 x 31 x 2,6	34,5 x 34,5 x 2,6	62,6 x 31 x 2,6	62,6 x 62,6 x 2,6	31 x 31 x 2,6	62,6 x 31 x 2,6	31 x 4 x 4
€/PIECE	€/PIECE	€/PIECE	€/PIECE	€/PIECE	€/PIECE	€/PIECE
70,30 €	141,12 €	52,52 €	131,69 €	180,95 €	131,69 €	6,59 €

PSM - PACK SISTEMA MINIMAL

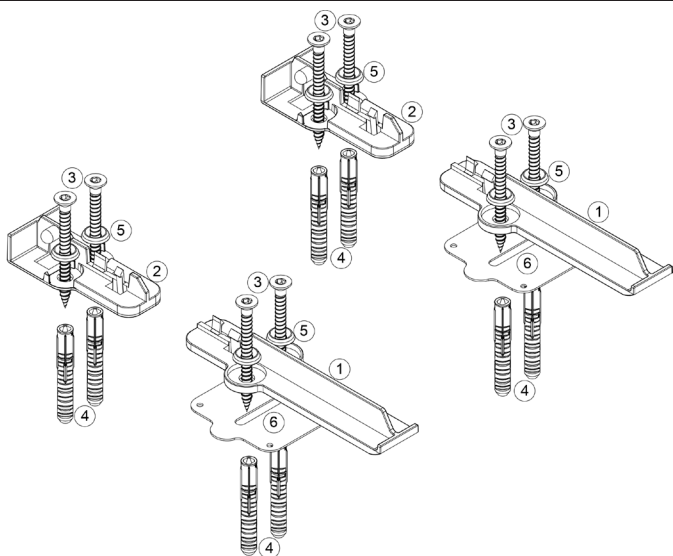

- ① - Pletina Frontal / Frontal Support 2 ud
- ② - Pletina Posterior / Back Support 2 ud
- ③ - Tornillos Inox A4 / Stainless Steel Screws A4 8 ud
- ④ - Tacos / Anchor Plugs 8 ud
- ⑤ - Ovalillo de ajuste Inox / Stainless Steel Oval Washer 8 ud
- ⑥ - Pletina Niveladora / Leveling plate 2 ud

€/PACK
46,75 €

OPENING SYSTEM

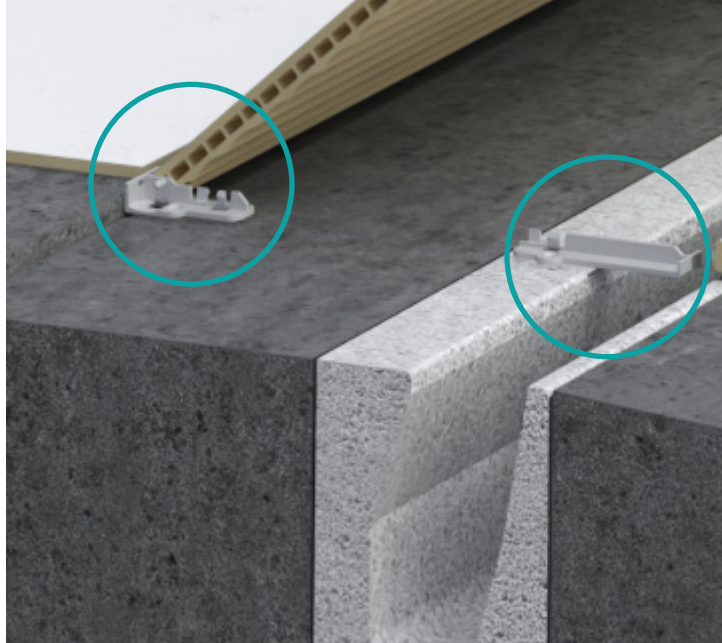

JSM	
SEALING JOINT, REMOVABLE	
Blanco	Gris cemento
€/10 m	
13,75 €	

DECK-LEVEL POOL / ERGO PLUS SYSTEM WITH COMPACT GRID

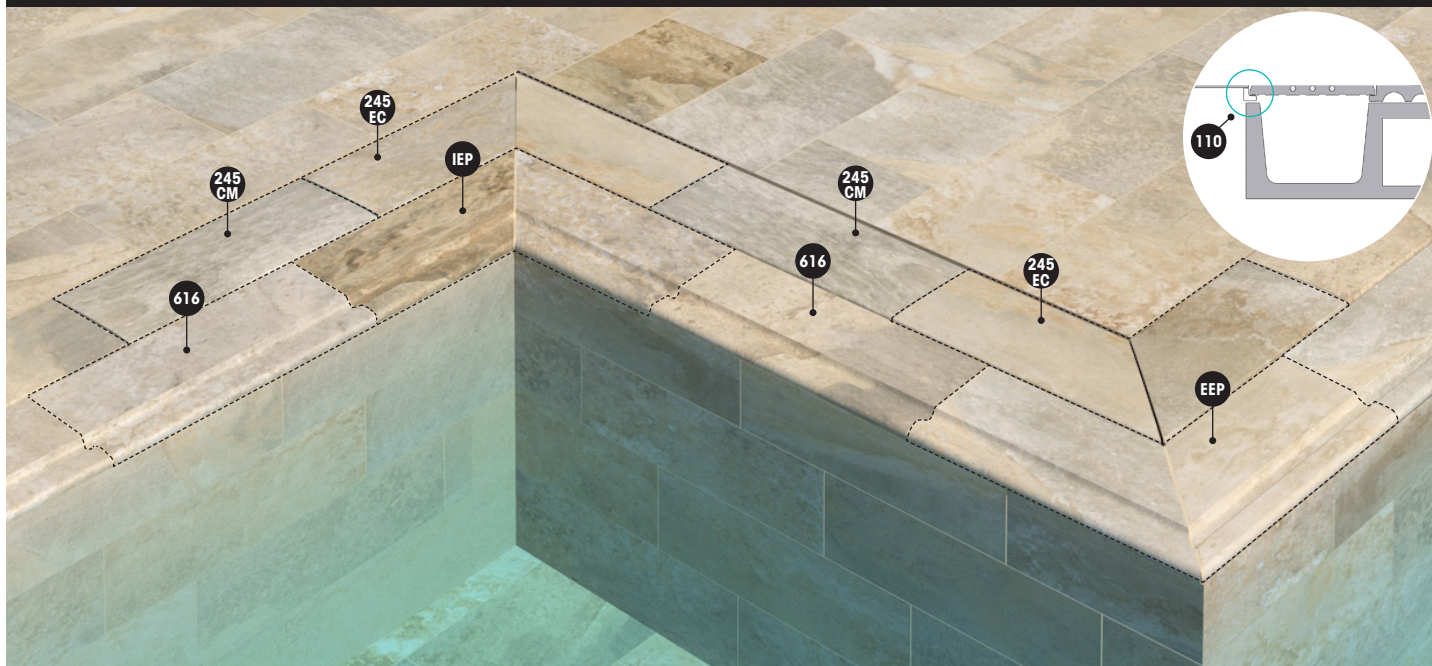

616	IEP	EEP	245 CM	245 EC	110
62,6 x 26,2	62,6 x 62,6	62,6 x 62,6	62,6 x 24,5 x 2,2	62,6 x 62,6 x 2,2	24,4 x 2,5
€/PIECE	€/PIECE	€/PIECE	€/PIECE	€/PIECE	€/PIECE
50,05 €	122,31 €	122,31 €	115,24 €	98,81 €	5,19 €

DECK-LEVEL POOL / ERGO PLUS SYSTEM / S9 BLOCKS *

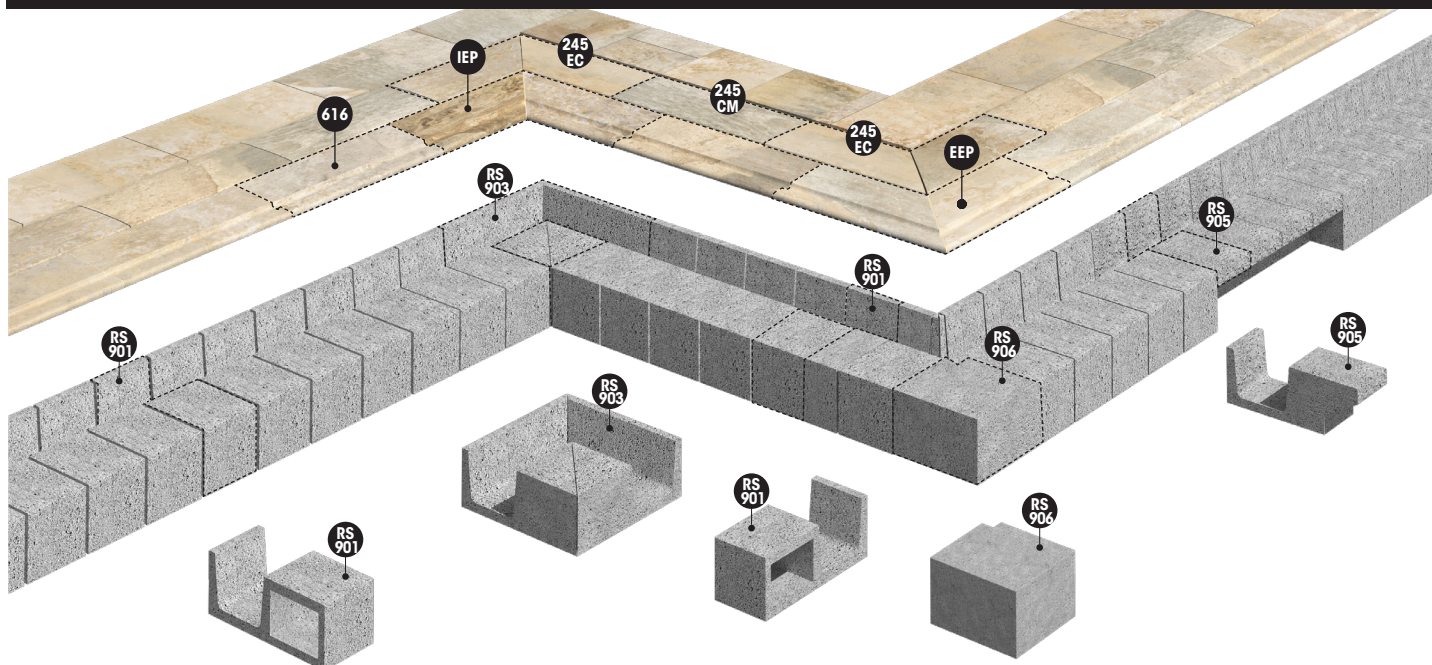

RS 901	RS 902	RS 903	RS 904	RS 905	RS 906
Base	Open built-in stairs	Inside corner	Solid piece	Closed built-in stairs	Outside corner
49,6 x 19,5 x 18,7	36,7 x 19,5 x 18,7	49,6 x 49,6 x 18,7	49,6 x 19,5 x 18,7	49,6 x 19,5 x 18,7	29,5 x 29,5 x 18,7
€/PIECE	€/PIECE	€/PIECE	€/PIECE	€/PIECE	€/PIECE
9,58 €	33,06 €	100,01 €	33,06 €	33,06 €	131,55 €

The S9 blocks are exclusively made with Rosa Gres ceramic tiles

DECK-LEVEL POOL / PRESTIGE SYSTEM WITH FLEX GRID



647	664	665	E65	316 NU	245 FL	245 EF
				 Depth Numbers		
62,6 x 31 x 2,6	62,6 x 62,6 x 2,6	62,6 x 62,6 x 2,6	31 x 31 x 2,6	62,6 x 31 x 0,9	49,5 x 24,5 x 2,2	26,6 x 26,6 x 2,2
€/PIECE	€/PIECE	€/PIECE	€/PIECE	€/PIECE	€/PIECE	€/PIECE
52,52 €	131,69 €	131,69 €	180,95 €	113,01 €	98,81 €	110,53 €

DECK-LEVEL POOL / SYSTEM S9 PRESTIGE / S9 BLOCKS *

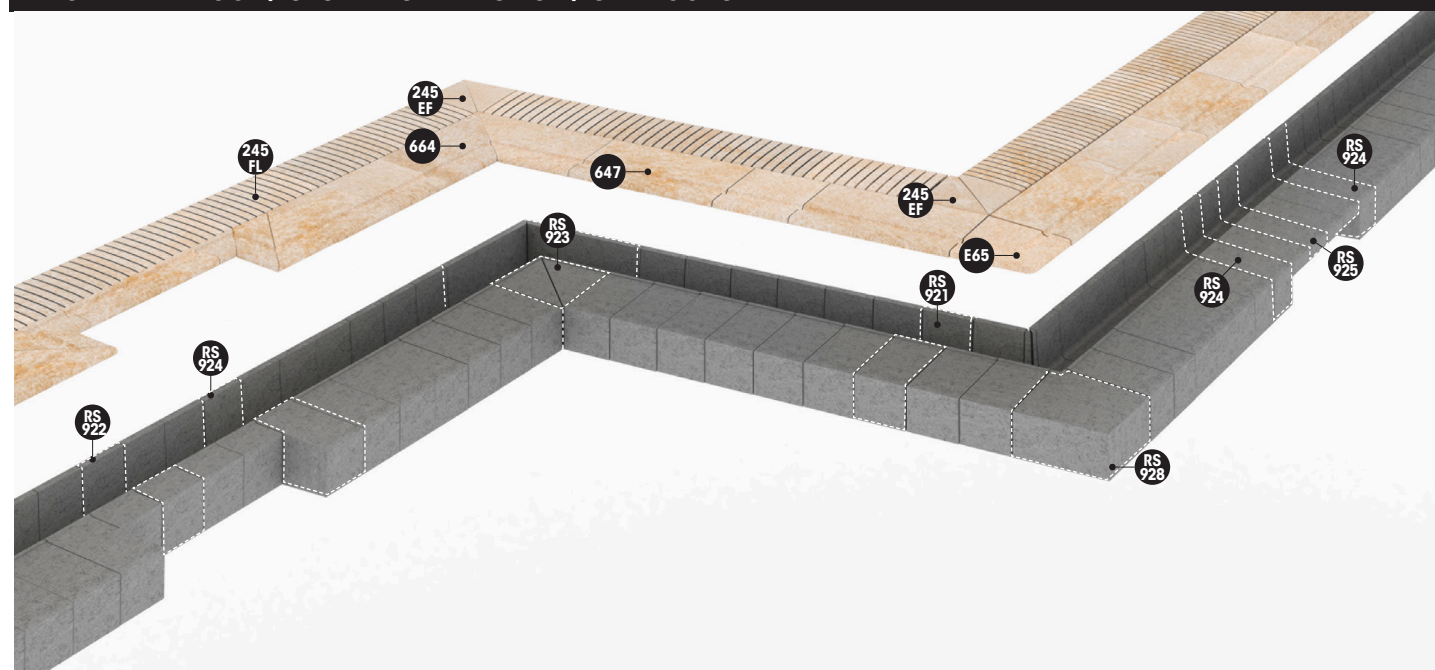

RS 921	RS 922	RS 923	RS 924	RS 925	RS 928
Base	Open built-in stairs	Inside corner	Solid piece	Closed built-in stairs	Outside corner
55,9 x 19,5 x 20,6	37,2 x 19,5 x 20,6	55,4 x 55,4 x 20,6	55,9 x 19,5 x 20,6	55,4 x 19,5 x 20,6	35,8 x 35,8 x 20,6
€/PIECE	€/PIECE	€/PIECE	€/PIECE	€/PIECE	€/PIECE
12,62 €	35,23 €	131,55 €	35,23 €	35,23 €	157,63 €

The S9 blocks are exclusively made with Rosa Gres ceramic tiles

DECK-LEVEL POOL / SMART SYSTEM

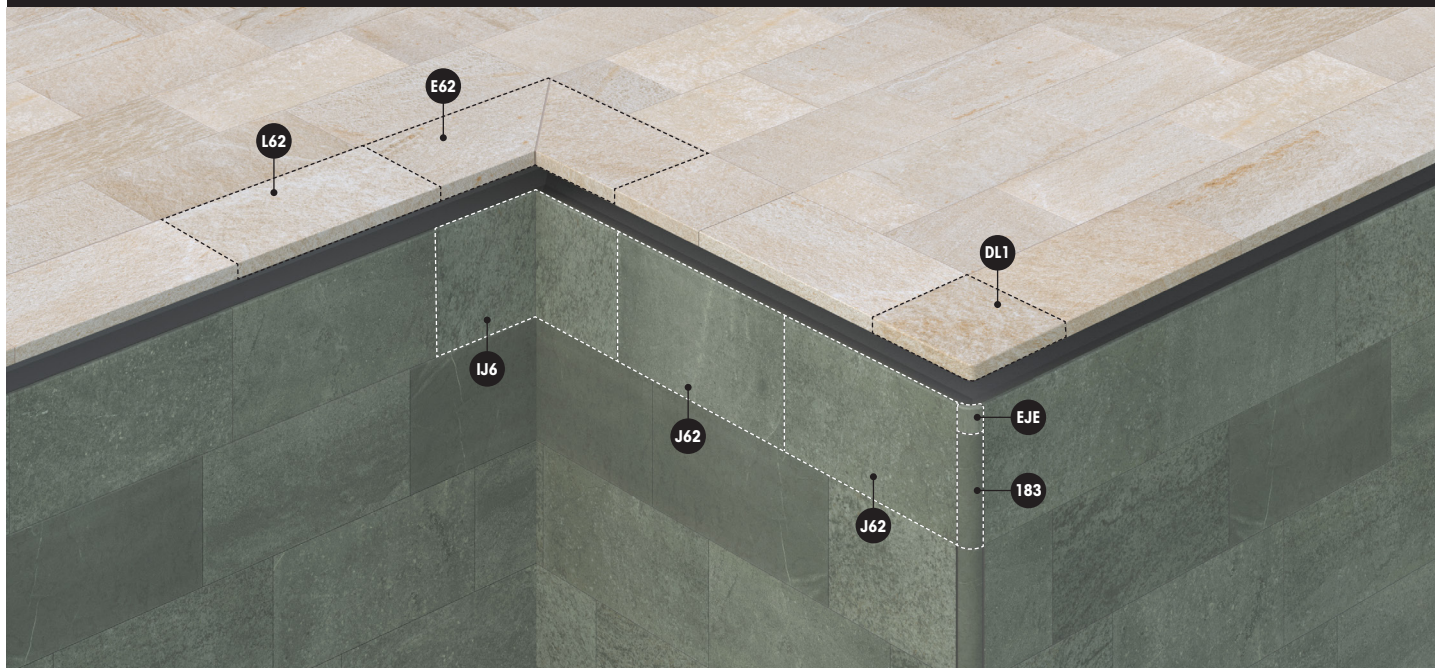

L62	E62	DL1	J62	IJ6	EJE	183
62,6 x 31,7 x 3,8	62,6 x 62,6 x 3,8	31,7 x 31,7 x 3,8	62,6 x 31 x 3,8	31 x 31 x 31	4 x 4 x 4	31 x 4 x 4
€/PIECE	€/PIECE	€/PIECE	€/PIECE	€/PIECE	€/PIECE	€/PIECE
41,49 €	141,12 €	98,81 €	52,52 €	131,69€	26,50 €	6,59 €

DECK-LEVEL POOL / SYSTEM S9 SMART / S9 BLOCKS *

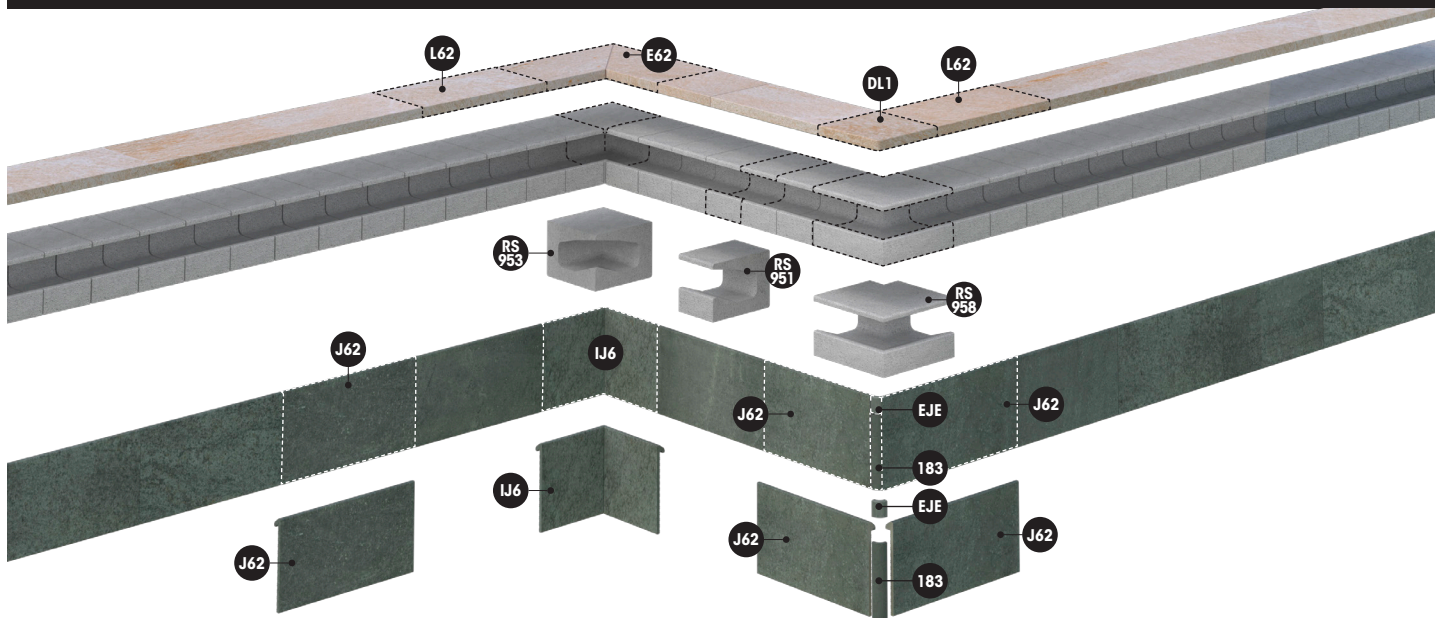

RS 951	RS 953	RS 958
Base	Inside corner	Outside corner
29,7 x 19,5 x 20,8	29,7 x 29,7 x 20,8	36,7 x 36,7 x 20,8
€/PIECE	€/PIECE	€/PIECE
12,62 €	131,55 €	192,58 €

The S9 blocks are exclusively made with Rosa Gres ceramic tiles



DECK-LEVEL POOL / SLIM SYSTEM WITH FLEX GRID

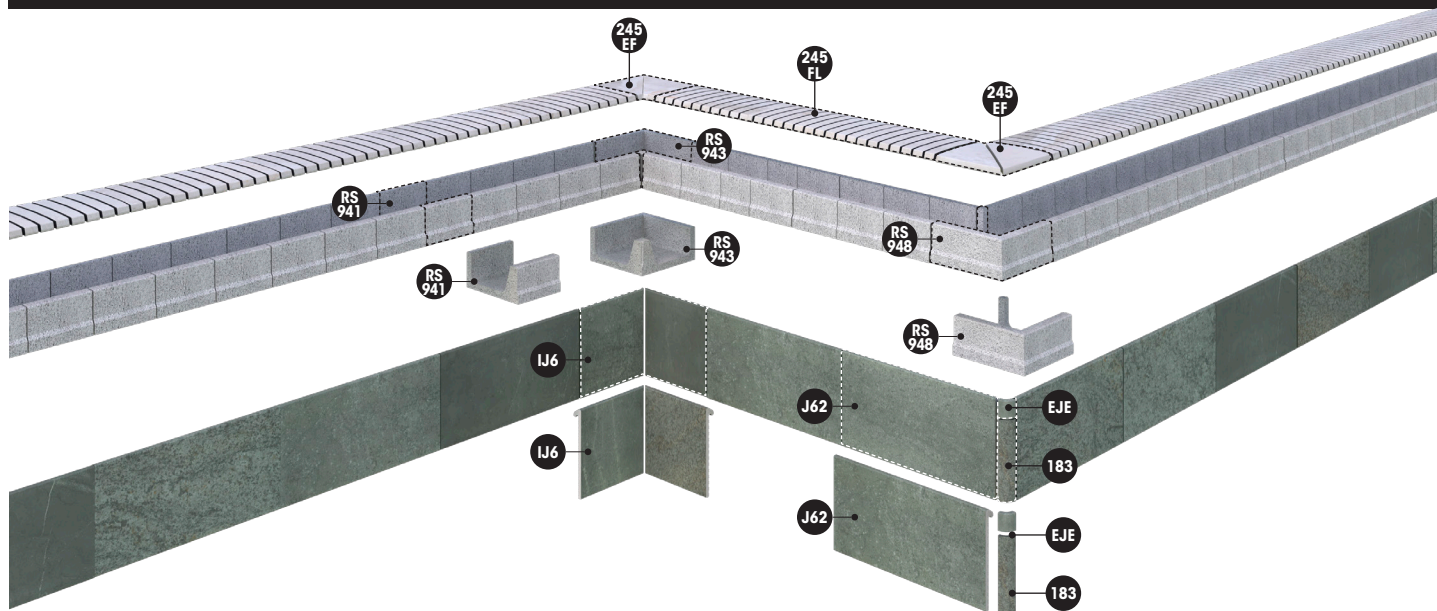

245 FL	245 EF	J62	IJ6	EJE	183
					
49,5 x 24,5 x 2,2	26,6 x 26,6 x 2,2	62,6 x 31 x 3,8	31 x 31 x 31	4 x 4 x 4	31 x 4 x 4
€/PIECE	€/PIECE	€/PIECE	€/PIECE	€/PIECE	€/PIECE
98,81 €	110,53 €	52,52 €	131,69€	26,50 €	6,59 €

DECK-LEVEL POOL / SYSTEM S9 SLIM / S9 BLOCKS *

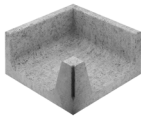

RS 941	RS 943	RS 948
Base	Inside corner	Outside corner
		
28 x 19 x 12,6	28 x 28 x 12,6	28 x 28 x 12,6
€/PIECE	€/PIECE	€/PIECE
12,62 €	100,01 €	100,01 €

The S9 blocks are exclusively made with Rosa Gres ceramic tiles

COLORS Rosa Gres

FOR USE IN POOL TANKS.

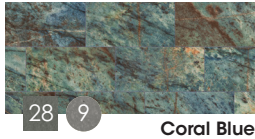

Coral Blue



Cuore Verde



Trésor Bali



Trésor Java

FOR OUTDOOR AND INDOOR USE AND FOR USE IN POOL TANKS.



Coral Sand



Cuore Rosso



Cuore Beige

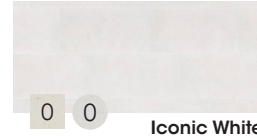

Iconic White



Iconic Grey



Mistery White



Mistery Sand



Mistery Grey



Mistery B. Stone



Mythos Selene



Mythos Dune



Mythos Antique

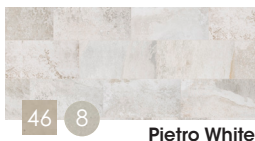

Pietro White



Pietro Golden



Pietro Grey



Pietro Dark



Serena Bianco



Serena Odra

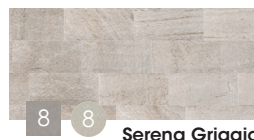

Serena Griggio

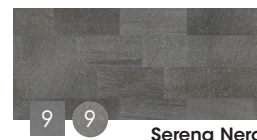

Serena Nero



Serena Mix

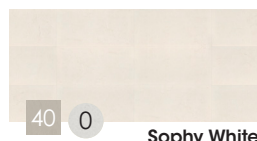

Sophy White



Sophy Beige



Sophy Grey

FOR USE IN TERRACES. SUITABLE FOR POOL TANK.



Alma Pure



Alma Honey



Alma Forest



Alma Mist



Stela White



Stela Golden



Stela Grey



Stela Dark

GROUT RECOMMENDED BY ROSA GRES

Ideal Color / Ideal Pool



Cerpxi / Professional PX



	MMO Rectified	MMO Rectified	50M Rectified	50M Anti-slip	50M 2cm Rectified	316	316	316 Pastilla	199	310 BH ¹⁻²	310 BH ¹⁻²	316 NU ³	
	97,9x97,9x1		48,8x97,9x1	48,8x97,9x1	48,8x97,9x2	31 x 62,6x0,9		31 x 62,6x0,9	19,4x97,9x1	31,3x31,3(4,9x4,9(u))		31 x 62,6x0,9	
	Smooth	Anti-slip	Smooth	Anti-slip	Anti-slip	Smooth	Anti-slip	Pastilla	Anti-slip	Smooth	Anti-slip	Anti-slip	
€	45,25 €		38,93 €		70,50 €	34,49 €		34,49 €	41,95 €	16,40 € ⁴		113,01 € ⁴	
Coral Blue								•				•	•
Cuore Verde								•				•	•
Trésor Bali								•				•	•
Trésor Java								•				•	•
Coral Sand		•		•				•					•
Cuore Rosso	•	•	•	•				•					•
Cuore Beige	•	•	•	•				•					•
Iconic White	•	•	•	•	•			•			•		•
Iconic Grey	•	•	•	•	•			•					•
Mistery White			•	•		•	•			•			•
Mistery Sand			•	•		•	•			•			•
Mistery Grey			•	•		•	•			•			•
Mistery Blue S.			•	•		•	•			•			•
Mythos Selene			•	•			•						•
Mythos Dune			•	•			•						•
Mythos Antique			•	•			•						•
Pietro White			•	•	•		•	•				•	•
Pietro Golden			•	•	•		•	•				•	•
Pietro Grey				•			•	•					•
Pietro Dark				•			•	•					•
Serena Bianco			•	•			•						•
Serena Odra			•	•			•						•
Serena Griggio							•						•
Serena Nero							•						•
Serena Mix							•				•		•
Sophy White	•	•	•	•			•						•
Sophy Beige	•	•	•	•			•						•
Sophy Grey	•	•	•	•			•						•
Alma Forest									•				
Alma Honey									•				
Alma Mist									•				
Alma Pure									•				
Stela White									•				
Stela Golden									•				
Stela Grey									•				
Stela Dark									•				
Packing													
x m ²	22,53		22,53		46,25		20,45		22,36		-		20,45
x	2		3		1		6		6		9		6
x m ²	1,04		2,09		2,09		5,15		5,26		-		5,15
m ² x	1,917		1,433		0,4778		1,165		1,14		-		1,165
x	22		32		36		40		45		48		40
m ² x	42,17		45,86		17,225		46,6		51,30		-		46,6
x	-		-		-		-		-		1,97		-

¹ Porcelain mesh-mounted mosaic tiles / ² Other colors: available upon request. Minimum order: 100 pieces / ³ Depth Numbers / ⁴ €/Piece

SKIMMER POOL									
	L62	E62	L98	E98	DL1	DL2	S62	DS1	S13
	62,6x31,7x3,8	62,6x62,6	97,9x31,7x3,8	97,9x97,9x3,8	31,7x31,7x3,8		62,6x31x2,6	31x31x2,6	46x46x2,6
	Anti-slip	Anti-slip	Smooth Anti-slip	Anti-slip					
€	41,49 €	141,12 €	68,25 €	268,11 €	98,81€	58,81 €	40,21 €	122,31 €	98,81 €
Coral Blue	•	•			•		•	•	•
Cuore Verde	•	•			•		•	•	•
Trésor Bali	•	•			•		•	•	•
Trésor Java	•	•			•		•	•	•
Coral Sand	•	•	•	•	•		•	•	•
Cuore Rosso	•	•	•	•	•		•	•	•
Cuore Beige	•	•	•	•	•				
Iconic White	•	•	•	•	•		•	•	•
Iconic Grey	•	•	•	•	•		•	•	•
Mistery White	•	•	•	•	•		•	•	•
Mistery Sand	•	•	•	•	•		•	•	•
Mistery Grey	•	•	•	•	•		•	•	•
Mistery Blue S.	•	•		•	•		•	•	•
Mythos Selene	•	•	•	•	•		•	•	•
Mythos Dune	•	•	•	•	•		•	•	•
Mythos Antique	•	•		•	•				
Pietro White	•	•	•	•	•		•	•	•
Pietro Golden	•	•	•	•	•		•	•	•
Pietro Grey	•	•		•	•		•	•	•
Pietro Dark	•	•		•	•		•	•	•
Serena Bianco	•	•	•	•	•		•	•	•
Serena Ocra	•	•	•	•	•		•	•	•
Serena Griggio	•	•			•		•	•	•
Serena Nero	•	•			•				
Serena Mix	•	•			•		•	•	•
Sophy White	•	•	•	•	•		•	•	•
Sophy Beige	•	•	•	•	•				
Sophy Grey	•	•	•	•	•				
Alma Forest				•	•	•			
Alma Honey				•	•	•			
Alma Mist				•	•	•			
Alma Pure				•	•	•			
Stela White				•	•	•			
Stela Golden				•	•	•			
Stela Grey				•	•	•			
Stela Dark				•	•	•			
Packing									
	6,5	9	10,19	16,8	2,25	3,25	7,46	3,80	5,93
	4	2	2	1	3	3	4	3	1
	24	32	30	30	30	30	24	30	-

Rosa Gres declines all responsibility concerning typographical errors.

DECK LEVEL POOL



62,6x31 x2,6 62,6x62,6x2,6 62,6x62,6x2,6 31 x31 x2,6 62,6x31 x3,8 31 x31 x31 4x4x4 49,5x24,5x2,2 26,6x26,6x2,2 62,6x24,5x2,2 62,6x62,6x2,2











Anti-slip

€	52,52 €	131,69 €	131,69 €	180,95 €	52,52 €	131,69 €	26,50 €	98,81 €	110,53 €	115,24 €	98,81 €
Coral Blue	•	•	•	•	•	•	•	•	•	•	•
Cuore Verde	•	•	•	•	•	•	•	•	•	•	•
Trésor Bali	•	•	•	•	•	•	•	•	•	•	•
Trésor Java	•	•	•	•	•	•	•	•	•	•	•
Coral Sand	•	•	•	•				•	•	•	•
Cuore Rosso	•	•	•	•				•	•	•	•
Cuore Beige	•	•	•	•				•	•	•	•
Iconic White	•	•	•	•	•	•	•	•	•	•	•
Iconic Grey	•	•	•	•	•	•	•	•	•	•	•
Mistery White	•	•	•	•	•	•	•	•	•	•	•
Mistery Sand	•	•	•	•	•	•	•	•	•	•	•
Mistery Grey	•	•	•	•	•	•	•	•	•	•	•
Mistery Blue S.	•	•	•	•	•	•	•	•	•	•	•
Mythos Selene	•	•	•	•	•	•	•	•	•	•	•
Mythos Dune	•	•	•	•	•	•	•	•	•	•	•
Mythos Antique	•	•	•	•				•	•	•	•
Pietro White	•	•	•	•	•	•	•	•	•	•	•
Pietro Golden	•	•	•	•	•	•	•	•	•	•	•
Pietro Grey	•	•	•	•	•	•	•	•	•	•	•
Pietro Dark	•	•	•	•	•	•	•	•	•	•	•
Serena Bianco	•	•	•	•	•	•	•	•	•	•	•
Serena Ocra	•	•	•	•	•	•	•	•	•	•	•
Serena Griggio	•	•	•	•	•	•	•	•	•	•	•
Serena Nero	•	•	•	•				•	•	•	•
Serena Mix	•	•	•	•	•	•	•	•	•	•	•
Sophy White	•	•	•	•				•	•	•	•
Sophy Beige	•	•	•	•				•	•	•	•
Sophy Grey	•	•	•	•				•	•	•	•
Alma Forest								•	•	•	•
Alma Honey								•	•	•	•
Alma Mist								•	•	•	•
Alma Pure								•	•	•	•
Stela White								•	•	•	•
Stela Golden								•	•	•	•
Stela Grey								•	•	•	•
Stela Dark								•	•	•	•

Packing

	9,14	13,71	13,71	3,42	7,7	11,6	6,75	4,6	3,56	6,6	13,47
	4	1	1	3	4	1	4	1	4	4	1
	24	32	32	30	24	16	6,75	26	26	24	16



MINIMAL SYSTEM - REFURBISHMENT - INFINITY POOL

















BR6	ER6	BR9	ER9	ECB	E56	056	I31	EI3	ECI
									
62,6x50x2,6	62,6x62,6x2,6	97,9x50x2,6	97,9x97,9x2,6	52,8x52,8x2,6	5x4,3x0,9	62,6x5x9,9	62,6x31x2,6	62,6x62,6x2,6	34,6x34,6x2,6

Anti-slip

€	70,30 €	218,00 €	110,53 €	268,11 €	268,11 €	218,00 €	2,15 €	70,30 €	141,12 €	
Coral Blue	•	•			•	•	•	•	•	•
Cuore Verde	•	•			•	•	•	•	•	•
Trésor Bali	•	•			•	•	•	•	•	•
Trésor Java	•	•			•	•	•	•	•	•
Coral Sand			•	•	•					
Cuore Rosso	•	•	•	•	•			•	•	•
Cuore Beige										
Iconic White	•	•	•	•	•	•	•	•	•	•
Iconic Grey						•	•	•	•	•
Mistery White	•	•	•	•	•	•	•	•	•	•
Mistery Sand						•	•	•	•	•
Mistery Grey	•	•	•	•	•	•	•	•	•	•
Mistery Blue S.	•	•	•	•	•	•	•	•	•	•
Mythos Selene						•	•	•	•	•
Mythos Dune	•	•	•	•	•	•	•	•	•	•
Mythos Antique						•	•			
Pietro White	•	•	•	•	•	•	•	•	•	•
Pietro Golden	•	•	•	•	•	•	•	•	•	•
Pietro Grey	•	•	•	•	•	•	•	•	•	•
Pietro Dark	•	•	•	•	•	•	•	•	•	•
Serena Bianco						•	•	•	•	•
Serena Ocra	•	•			•	•	•	•	•	•
Serena Griggio						•	•	•	•	•
Serena Nero						•	•			
Serena Mix	•	•			•	•	•	•	•	•
Sophy White	•	•	•	•	•	•	•	•	•	•
Sophy Beige						•	•			
Sophy Grey						•	•			
Alma Forest			•	•	•					
Alma Honey										
Alma Mist										
Alma Pure										
Stela White										
Stela Golden										
Stela Grey										
Stela Dark										

Packing

	12	5,06	10,13	12,51	14,41	1,45	0,66	7,7	11,6	6,39
	3	2	2	2	2	1	36	4	1	1
	8	32	32	8	8	99	40	24	16	24

	HALF-ROUND PIECES									SHALLOW CHANNEL-PLINTH																			
	183	115	117	188	114	116	147 ¹	030 ²	040 ³	121CM	E21	Z62	ZLD	ZLI															
																													
	31 x 4 x 4		4 x 4		31 x 4 x 4		4 x 4		31 x 4 x 4			62,6 x 12,5	12,5 x 12,5 x 2,2	62,6 x 7	36,5 x 30 x 7														
	S	Anti	S	Anti	S	Anti	S	Anti	S	Anti	S	Anti	Anti-slip																
€	6,59 €		22,94 €		34,15 €		6,59 €		22,94 €		34,15 €		37,00 €			47,10 €			47,10 €			98,81 €		40,21 €		6,59 €		12,23 €	
Coral Blue		•		•		•		•		•		•		•		•		•		•		•		•		•		•	
Cuore Verde		•		•		•		•		•		•		•		•		•		•		•		•		•		•	
Trésor Bali		•		•		•		•		•		•		•		•		•		•		•		•		•		•	
Trésor Java		•		•		•		•		•		•		•		•		•		•		•		•		•		•	
Coral Sand		•		•		•		•		•		•		•		•		•		•		•		•		•		•	
Cuore Rosso		•		•		•		•		•		•		•		•		•		•		•		•		•		•	
Cuore Beige		•		•		•		•		•		•		•		•		•		•		•		•		•		•	
Iconic White		•		•		•		•		•		•		•		•		•		•		•		•		•		•	
Iconic Grey		•		•		•		•		•		•		•		•		•		•		•		•		•		•	
Mistery White	•	•	•	•	•	•	•	•	•	•	•	•	•	•	•	•	•	•	•	•	•	•	•	•	•	•	•	•	
Mistery Sand	•	•	•	•	•	•	•	•	•	•	•	•	•	•	•	•	•	•	•	•	•	•	•	•	•	•	•	•	
Mistery Grey	•	•	•	•	•	•	•	•	•	•	•	•	•	•	•	•	•	•	•	•	•	•	•	•	•	•	•	•	
Mistery Blue S.	•	•	•	•	•	•	•	•	•	•	•	•	•	•	•	•	•	•	•	•	•	•	•	•	•	•	•	•	
Mythos Selene		•		•		•		•		•		•		•		•		•		•		•		•		•		•	
Mythos Dune		•		•		•		•		•		•		•		•		•		•		•		•		•		•	
Mythos Antique																													
Pietro White		•		•		•		•		•		•		•		•		•		•		•		•		•		•	
Pietro Golden		•		•		•		•		•		•		•		•		•		•		•		•		•		•	
Pietro Grey		•		•		•		•		•		•		•		•		•		•		•		•		•		•	
Pietro Dark		•		•		•		•		•		•		•		•		•		•		•		•		•		•	
Serena Bianco		•		•		•		•		•		•		•		•		•		•		•		•		•		•	
Serena Ocra		•		•		•		•		•		•		•		•		•		•		•		•		•		•	
Serena Griggio		•		•		•		•		•		•		•		•		•		•		•		•		•		•	
Serena Nero		•		•		•		•		•		•		•		•		•		•		•		•		•		•	
Serena Mix		•		•		•		•		•		•		•		•		•		•		•		•		•		•	
Sophy White		•		•		•		•		•		•		•		•		•		•		•		•		•		•	
Sophy Beige		•		•		•		•		•		•		•		•		•		•		•		•		•		•	
Sophy Grey		•		•		•		•		•		•		•		•		•		•		•		•		•		•	
Alma Forest																													
Alma Honey																													
Alma Mist																													
Alma Pure																													
Stela White																													
Stela Golden																													
Stela Grey																													
Stela Dark																													
Packing																													
	0,43	0,05	0,12	0,55	0,08	0,11	0,55	0,57	0,57	2,94	0,81	0,97	0,83	0,83															
	18	70	30	14	34	30	14	18	14	5	4	20	20	20															
	102	-	-	102	-	-	102	102	102	40	100	41	41	41															

¹ Half-round piece with bullnose

² Interior half-round piece in a right angle

³ Exterior half-round piece in a right angle

HYDRO-EXPANDING CONSTRUCTION JOINT		01 FUGA-STOP 25x20 mm							CONSUMPTION		
		DIMENSIONS	UNIT	PRICE	Ut	x	Pa	Ut	x	Pa	
		25 x 20 mm	5 ml	F-216	6 rolls	30	180	560	1 ml / 1 ml		
	02 MASTIC MS							APPROXIMATE CONSUMPTION			
		COLORS	UNIT	PRICE	Ut	x	Pa	Ut	x	Pa	
		Transparent	290 ml	F-085	24	48	1152	334	1Ut / 20 ml the FUGA-STOP		

INTERNAL SEALING FOR PVC TUBES		01 FUGA-STOP MINI 20x10 mm							APPROXIMATE CONSUMPTION		
		DIMENSIONS	UNIT	PRICE	Ut	x	Pa	Ut	x	Pa	
		20 x 10 mm	10 ml	F-239	7 rolls	30	210	658	For PVC: 0,29 ml / tube		

EXTERNAL SEALING FOR PVC TUBES		IMPRIMACIÓN S10 + SELLADOR S10							APPROXIMATE CONSUMPTION		
		COLORS	UNIT	PRICE	Ut	x	Pa	Ut	x	Pa	
		Colorless	500 cm ³ LQ	F-185	18	24	432	216	0,08 lt / tube		
		Colorless	1 lt LQ	F-227	8	20	160	160			
		Grey	600 cm ³	F-100	12	66	792	475	0,25 Ut / tube		

MORTAR FOR WALLS		FIX-REVOCO							CONSUMPTION (cm of thickness)		
		COLORS	UNIT	PRICE	Ut	x	Pa	Ut	x	Pa	
		Grey	25 kg	F-070	-	-	56	1400	16 kg / m ²		

MORTAR FOR THE BOTTOM OF THE TANK		PRIMFIX + Pure cement (bonding bridge)							APPROXIMATE CONSUMPTION		
		COLORS	UNIT	PRICE	Ut	x	Pa	Ut	x	Pa	
		White	5 lts	F-145	-	-	100	500	PRIMFIX = 0,2 lts / m ²		
			25 lts	F-260	-	-	24	600	Cement = 0,2 kg / m ²		
	RECRECEM PRE-MIX							CONSUMPTION (cm of thickness)			
		COLORS	UNIT	PRICE	Ut	x	Pa	Ut	x	Pa	
		Grey	25 kg	F-080	-	-	56	1400	18 kg / m ²		

CEMENT-BASED WATERPROOFING SYSTEMS

FLEXIBLE CEMENT SOLUTION: IDEAL FOR IN-GROUND POOLS

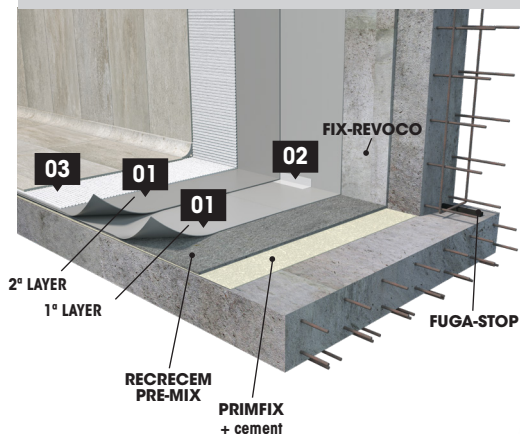

01 HIDROFIX								CONSUMPTION MAXIMUM (2 LAYERS)	
COLORS	UNIT.	PRICE	Ut. x	Ut. x	Ut. x	Ut. x	Ut. x		
Grey	25 kg	F-220	-	-	56	1400	2,5 kg / m ²		
White		F-230	-	-	56	1400			
02 BANDA IMPERMEABLE 120								CONSUMPTION	
DIMENSIONS	PRICE	Ut. x	Ut. x	Ut. x	Ut. x	Ut. x	Ut. x		
120 / 70 mm x 10 ml	F-190	-	-	100	46	1 ml / 1 ml			
03 FIXSET GEL								APROX. CONSUMPTION	
COLORS	UNIT.	PRICE	Ut. x	Ut. x	Ut. x	Ut. x	Ut. x	Tile Measurements	
Grey	25 kg	F-102	-	-	56	1400	31 x 62,6 cm	5,00 kg / m ²	
White		F-112	-	-	56	1400	48,8 x 97,9 cm	6,00 kg / m ²	

SUPER ELASTIC CEMENT SOLUTION: IDEAL FOR POOLS THAT CAN BE ACCESSED AND REPAIRED THROUGHOUT THEIR ENTIRE PERIMETER

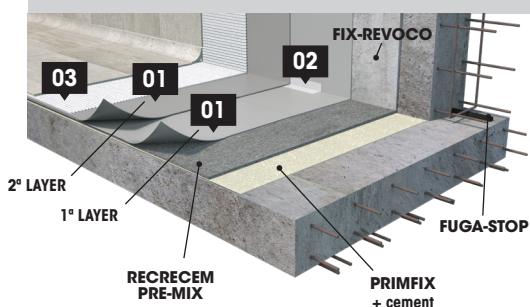

01 HIDROELASTIC 1200								CONSUMPTION MAXIMUM (2 LAYERS)	
COLORS	UNIT.	PRICE	Ut. x	Ut. x	Ut. x	Ut. x	Ut. x		
Grey	30 kg	F-265	-	-	40	1400	2,5 kg / m ²		
02 BANDA IMPERMEABLE 120								CONSUMPTION	
DIMENSIONS	PRICE	Ut. x	Ut. x	Ut. x	Ut. x	Ut. x	Ut. x		
120 / 70 mm x 10 ml	F-190	-	-	100	46	1 ml / 1 ml			
03 TECNOCOL GEL								APROX. CONSUMPTION	
COLORS	UNIT.	PRICE	Ut. x	Ut. x	Ut. x	Ut. x	Ut. x	Tile Measurements	
Grey	25 kg	F-130	-	-	56	1400	31 x 62,6 cm	5,00 kg / m ²	
White		F-140	-	-	56	1400	48,8 x 97,9 cm	6,00 kg / m ²	

WATERPROOFING SYSTEMS WITH LAMINA PROOF: MAXIMUM WATERTIGHTNESS, DURABILITY AND CHEMICAL RESISTANCE

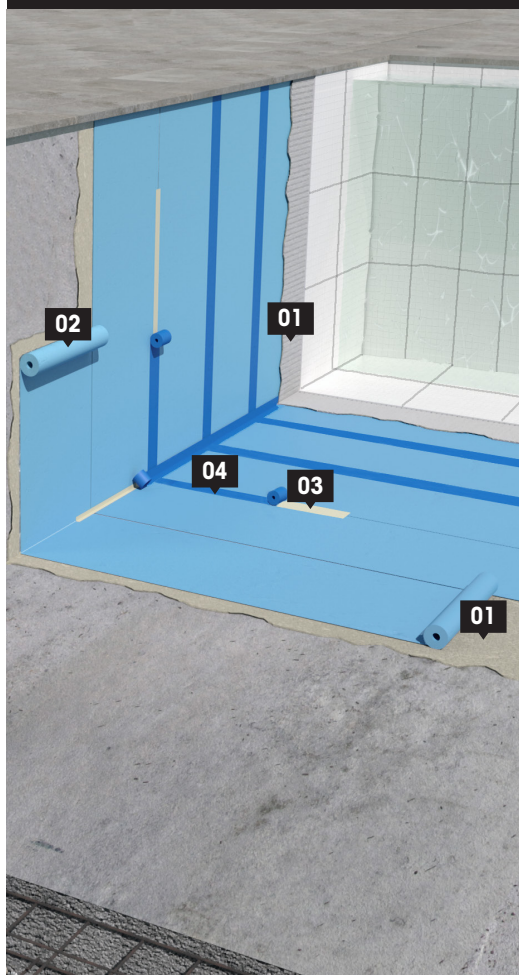

01 TECNOCOL GEL								ADHERING SHEET CONSUMPTION	
COLORS	UNIT.	PRICE	Ut. x	Ut. x	Ut. x	Ut. x	Ut. x	3,00 kg / m ²	
Grey	25 kg	F-130	-	-	56	1400	CERAMIC CONSUMPTION		
White		F-140	-	-	56	1400	Tile Measurements		
							31 x 62,6 cm	5,00 kg / m ²	
							48,8 x 97,9 cm	6,00 kg / m ²	
02 LAMINA PROOF PREMIUM								MAXIMUM CONSUMPTION	
DIMENSIONS	PRICE	Ut. x	Ut. x	Ut. x	Ut. x	Ut. x	Ut. x		
1 x 30 ml	F-317	-	-	24	195	1,05 m ² / 1,0 m ²			
03 EPOXICOL								APROX. CONSUMPTION	
COLORS	UNIT.	PRICE	Ut. x	Ut. x	Ut. x	Ut. x	Ut. x	0,3 - 0,5 kg / ml du BANDA SOLAPES	
	1,5 kg	F-152	-	-	72	108			
	5 kg	F-195	-	-	44	220			
	20 kg	F-285	-	-	12	240			
04 BANDA SOLAPES								CONSUMPTION	
DIMENSIONS	PRICE	Ut. x	Ut. x	Ut. x	Ut. x	Ut. x	Ut. x	Consulter Serv. Tech.	
12 cm x 50 ml	F-270	1	100	100	5000				
05 BANDA ESQUINAS								CONSUMPTION	
DIMENSIONS	PRICE	Ut. x	Ut. x	Ut. x	Ut. x	Ut. x	Ut. x		
12 x 12 x 12 cm INT	F-040	25	40	1000	50	1 Unit / inside corner			
12 x 12 x 12 cm EXT		1 Unit / outside corner							

TANK GROUTING

FOR CHLORINATED WATER: 8 COLORS

IDEAL POOL		COLORS	UNIT	PRICE	ut. x	x	ut. x	x	APPROXIMATE CONSUMPTION			
Resistant to weak acids		0 - 1 - 8	5 kg	F-122	4	36	144	720	Width x Length of the ceramic	Ceramic thickness	Joint width	Yield
		9 - 10 - 11							31 x 62,6 cm	9 mm	2 mm	0,14 kg / m ²
		46 - 48							48,8 x 97,9 cm	10 mm	3 mm	0,15 kg / m ²

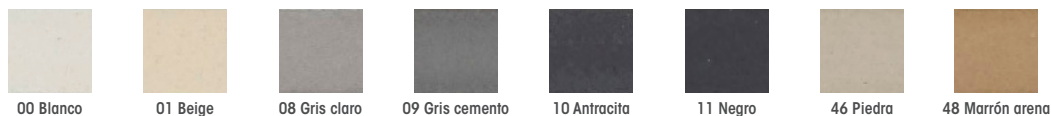

FOR CHLORINATED WATER AND SALT WATER CHLORINATION: 26 COLORS

MAXIMUM DURABILITY

CERPOXI		COLORS	UNIT	PRICE	ut. x	x	ut. x	x	APPROXIMATE CONSUMPTION			
Epoxy Anti-acid grouting for salt chlorination		0 - 30	2 kg	F-200	-	-	72	144	Width x Length of the ceramic	Ceramic thickness	Joint width	Yield
			7 kg	F-250	-	-	44	308				
			21 kg	F-300	-	-	12	252				
		The rest of colors	2 kg	F-180	-	-	12	252				
			7 kg	F-225	-	-	44	308				
			21 kg	F-280	-	-	12	252				

PROFESSIONAL PX		COLORS	UNIT	PRICE	ut. x	x	ut. x	x	APPROXIMATE CONSUMPTION			
Epoxy Anti-acid grouting for salt chlorination. Super fluid.		All colors	5 kg	F-215	-	-	44	220	Width x Length of the ceramic	Ceramic thickness	Joint width	Yield
			20 kg	F-295	-	-	12	240				

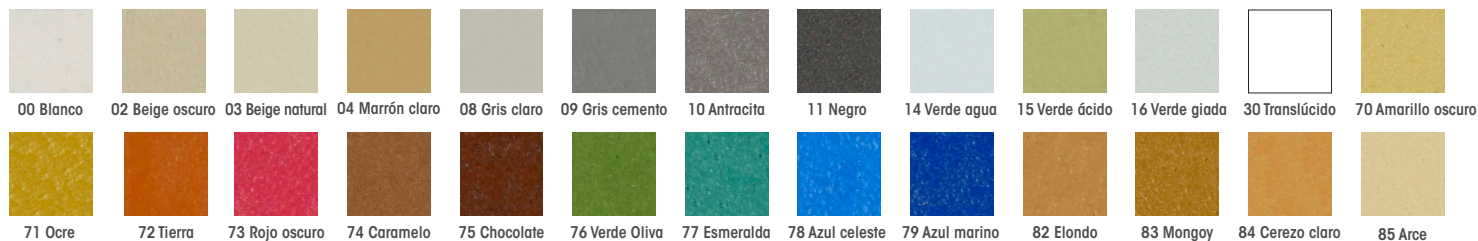

DECK GROUTING

IDEAL COLOR		COLORS	UNIT	PRICE	ut. x	x	ut. x	x	APPROXIMATE CONSUMPTION			
Colored grout concrete base		0-1-8-9-24-25-26-29 46-47-48-67-68	5 kg	F-111	4	36	144	720	Width x Length of the ceramic	Thicknes	Width joint	Yield
		4-5-7-10-12-19-27 28-33-34-36-40							300 x 300 mm	9 mm	2 mm	0,23 Kg / m ²
		11-23-35-37-38- 45-69							300 x 600 mm	9 mm	2 mm	0,17 Kg / m ²
		32-66							300 x 600 mm	9 mm	6 mm	0,51 Kg / m ²
		0-9							500 x 1000 mm	9 mm	2 mm	0,10 Kg / m ²
			25 kg	F-213	-		56	1400	500 x 1000 mm	9 mm	6 mm	0,31 Kg / m ²
									1000x1200mm	3 mm	1 mm	0,01 Kg / m ²



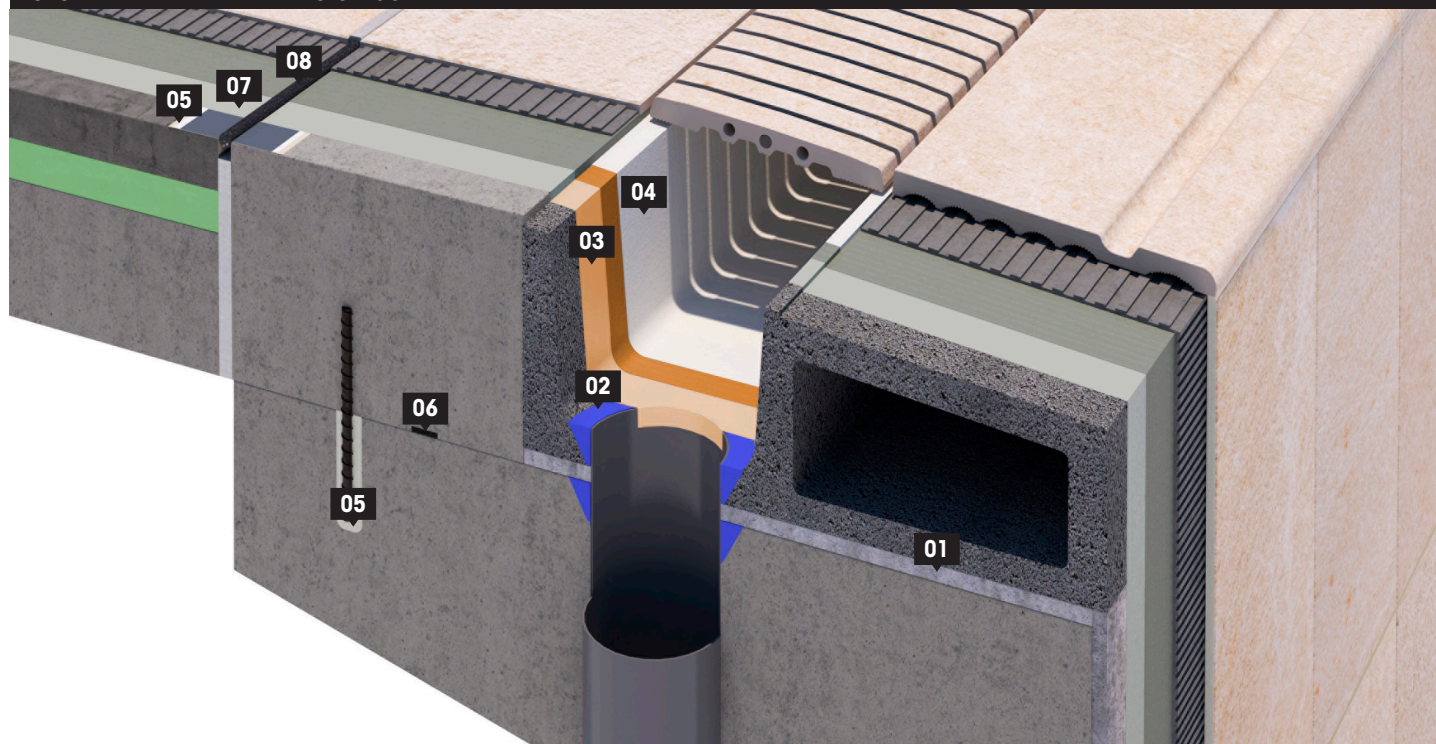























SYSTEM 9 AND THE EXPANSION JOINT

01	PRIMFIX + mortero M7.5	COLORS	UNIT	PRICE	ut. x	ut. x	ut. x	ut. x	APPROXIMATE CONSUMPTION
Adhesive mortar for the S9 pieces		White	5 lts	F-145	-	-	102	510	PRIMFIX = 2,5 lts / ml
			25 lts	F-260			24	600	Mortar = 25 kg / ml
02	Impr.S10 + Sellador S10	COLORS	UNIT	PRICE	ut. x	ut. x	ut. x	ut. x	APPROXIMATE CONSUMPTION
Primer & ultra-elastic sealant		Colorless	500 cm ³ LQ	F-185	18	24	432	216	0,08 lt / tube
		Colorless	1 lt LQ	F-227	8	20	160	160	
		Grey	600 cm ³	F-100	12	66	792	475	0,25 Ut. / tube
03	HIDROFIX	COLORS	UNIT	PRICE	ut. x	ut. x	ut. x	ut. x	MAXIMUM CONSUMPTION (2 LAYERS)
Waterproofing		Grey	25 kg	F-220	-	-	56	1400	2,5 kg / m ²
		White		F-230					
04	EPOXICOLOR POOL	COLORS	UNIT	PRICE	ut. x	ut. x	ut. x	ut. x	APPROXIMATE CONSUMPTION (2 LAYERS)
High chemical resistant epoxy paint		White Black	2,5 kg	F-197	1	48	48	120	0,30 kg / m ²
05	EPOXICOL	COLORS	UNIT	PRICE	ut. x	ut. x	ut. x	ut. x	APPROXIMATE CONSUMPTION
Reactive resin adhesive			1,5 kg	F-152	-	-	72	108	0,5 - 0,75 kg / ml de FIX-TAPE 170 mm
		Beige	5 kg	F-195	-	-	44	220	
			20 kg	F-285	-	-	12	240	
06	FUGA-STOP MINI 20x10mm	DIMENSIONS	UNIT.	CODE PRIX	ut. x	ut. x	ut. x	ut. x	APPROXIMATE CONSUMPTION
Joint for the wall behind S9		20 x 10 mm	10 ml	F-239	7 rou- leaux	30	210	658	For the S9 wall: 1 ml / 1 ml
07	FIX-TAPE 170 mm	DIMENSIONS	UNIT.	CODE PRIX	ut. x	ut. x	ut. x	ut. x	CONSUMPTION
Watertight thermoplastic strip		170 mm x 1,5 mm	30 ml	F-307	-	-	36	140	1 ml / 1 ml
08	SELLALASTIC FOAM	COLORS	UNIT	PRICE	ut. x	ut. x	ut. x	ut. x	CONSUMPTION
Polyethylene cord. Bottom of joint		Grey	15 mm	F-005	-	8	4400	22	1 ml / 1 ml
			20 mm	F-010			2800	21	

POOL DECKS



01 PAVIFORT		COLORS	UNIT	PRICE	ut. x 	 x 	ut. x 	 x 	APPROXIMATE CONSUMPTION			
Screed mortar		Grey	25 kg	F-060	-	-	56	1400	18 kg / m ² x cm			
02 IMPRIMACIÓN S10		COLORS	UNIT	PRICE	ut. x 	 x 	ut. x 	 x 	APPROXIMATE CONSUMPTION			
For absorbent surfaces		Colorless	500 cm ³ LQ	F-185	18	24	432	216	0,08 lts / drain			
			1 lt LQ	F-227	8	20	160	160				
03 SELLADOR S10		COLORS	UNIT	PRICE	ut. x 	 x 	ut. x 	 x 	APPROXIMATE CONSUMPTION			
Ultra-elastic watertight filler		Grey	600 ml	F-100	12	66	792	475	0,25 Ut. / drain			
04 FIX-BANDA DRAIN		DIMENSIONS		PRICE	ut. x 	 x 	ut. x 	 x 	APPROXIMATE CONSUMPTION			
Self-adhesive watertight sheet for the drain		400 x 400 x 0,8 mm		F-075	25	10	250	22	1 Ut. / drain			
05 HIDROFACIL		COLORS	UNIT	PRICE	ut. x 	 x 	ut. x 	 x 	APPROXIMATE CONSUMPTION (2 layers)			
Waterproofing		Blue	5 kg	F-210	-	-	72	360	1 kg / m ²			
			25 kg	F-275	-	-	16	400				
06 BANDA IMPERMEABLE 120		DIMENSIONS		PRICE	ut. x 	 x 	ut. x 	 x 	APPROXIMATE CONSUMPTION			
Elastic and waterproof tape		120 / 70 mm x 10 ml		F-190	-	-	100	46	1 ml / ml			
07 TECNOCOL GEL		COLORS	UNIT	CODE PRIX	ut. x 	 x 	ut. x 	 x 	APPROXIMATE CONSUMPTION			
Adhesive		Grey	25 kg	F-130	-	-	56	1400	Tile Measurements			
				F-140					31 x 62,6 cm	5,00 kg / m ²		
		White	F-127	48,8 x 97,9 cm	6,00 kg / m ²							
		0-9	25 kg	F-213					19,4 x 97,9 cm	6,00 kg / m ²		
08 IDEAL COLOR		COLORS	UNIT	PRICE	ut. x 	 x 	ut. x 	 x 	CONSUMPTION APPROXIMATIVE			
Colored grout		0-1-8-9-24-25-26-29 46-47-48-67-68	5 kg	F-111	4	36	144	720	Width x Length of the ceramic	Thickness	Width joint	Yield
		4-5-7-10-12-19-27 28-33-34-36-40		F-114					300 x 300 mm	9 mm	2 mm	0,23 Kg / m ²
		11-23-35-37-38- 45-69		F-127					300 x 600 mm	9 mm	2 mm	0,17 Kg / m ²
		32-66		F-177					300 x 600 mm	9 mm	6 mm	0,51 Kg / m ²
		0-9	F-213	500 x 1000 mm	9 mm	2 mm	0,10 Kg / m ²					
								500 x 1000 mm	9 mm	6 mm	0,31 Kg / m ²	
									1000 x 1200 mm	3 mm	1 mm	0,01 Kg / m ²
09 SELLALASTIC		COLORS	UNIT	PRICE	ut. x 	 x 	ut. x 	 x 	CONSUMPTION APPROXIMATIVE			
Expansion joint		0-9-11-45	310 ml	F-045	25	48	1200	372	0,33 Ut. / ml			

CLEANERS

EPOXINET		UNIT	PRICE	Ut. x	x	Ut. x	x	MAXIMUM CONSUMPTION
Facilitates cleaning CERPOXI and PROFESSIONAL PX joint residues when they are being applied.		5 lts	F-255	-	-	102	510	0,05 lts / m ²
EPOXI CLEANER		UNIT	PRICE	Ut. x	x	Ut. x	x	MAXIMUM CONSUMPTION
Removes dry CERPOXI and PROFESSIONAL PX joint residues		1 lts LQ	F-125	12	24	288	288	0.15 - 0.25 lts / m ²
		5 lts	F-235	-	-	102	510	
		25 lts	F-315	-	-	24	600	
GRESNET		UNIT	PRICE	Ut. x	x	Ut. x	x	MAXIMUM CONSUMPTION
Cleaning acid. Eliminates leftover cement and cement-based grouts stuck to the tile.		1 lts LQ	F-025	12	32	384	384	0,05 lt / m ²
		5 lts LQ	F-135	2	64	128	640	
		25 lts	F-245	-	-	24	600	

TOOLS: FOR GROUTING

FIX-ESPATULA HARD RUBBER SPATULA PRICE F-065	FIX-LLANA CLEANING TROWEL PRICE F-110	FIX-ESTROPAJO WHITE REPLACEMENT SCOURER PRICE F-015	FIX-ESTROPAJO BLACK REPLACEMENT SCOURER PRICE F-015	FIX-BUCKET WITH A SPONGE TROWEL PRICE F-205
FIX-LLANA SPONGE TROWEL PRICE F-090	FIX-ESPONJA SPONGE REPLACEMENT PRICE F-030	JARRA DOSIFICADORA 5 lt. PRICE F-165	ANTI-DRIP CAULK GUN FOR CARTRIDGES PRICE F-166	ROBUST GUN FOR SACHETS PRICE F-178

STEP-BY-STEP VIDEOS



MASTIC MS +
FUGA-STOP 25 x 20 mm



FUGA-STOP MINI
20 x 10 mm



SELLADOR S10



FIX-REVOCO



PRIMFIX +
RECCEM-PRE-MIX



HIDROELASTIC



LAMINA PROOF



EPOXICOL +
BANDA-SOLAPES



TECNOCOL GEL
TO GLUE S9 BLOCKS



TECNOCOL GEL
FORTILE INSTALLATION



PROFESSIONAL PX



HIDROFIX +
EPOXICOLOR POOL



Cover / Back cover: Trésor Bali & Alma Honey.



Rosa Gres, SLU

Central office

Ctra. Sant Cugat, km. 3
08290 Cerdanyola, Barcelona, Spain
Tel. + 34 93 586 30 60
Ventas: + 34 93 586 37 00
Export Sales: + 34 93 586 37 02
info@rosagres.com
www.rosagres.com

Rosa Gres France, SARL

64140 Lons, France
Tel. + 33 04 11 92 00 30
contact@rosagres.com
administration@rosagres.com
www.rosagres.com/fr

Factory

Pol. Ind. Mas Vell
Ramón Sugrañes, 1
43144 Vallmoll, Tarragona, Spain

January 2026

