

Tarifa  
Price list  
Liste de prix

2026



## JUNTA DE COLOCACIÓN MÍNIMA (Pieza base)

Se precisa una junta mínima de colocación de 2mm para los formatos 48,8 x 97,9 liso-rectificado y para los formatos 97,9 x 97,9 liso y antideslizante rectificadas. En el formato 48,8 x 97,9 cm en antideslizante, se recomienda una junta mínima de 3 mm. Cuando se quiera modular la pieza base ref. 316 (31 x 62,6 cm) con la pieza especial, la junta deberá ser de 6 mm. La pieza especial también requiere de una junta de colocación entre piezas. El grosor de esta junta oscilará entre los 2 mm y los 6 mm según el formato de la pieza.

## MINIMUM JOINT (Field tiles)

A minimum installation joint of 2 mm is required for the 48.8 x 97.9 smooth-rectified formats and for the 97.9 x 97.9 smooth and anti-slip rectified formats. A minimum joint of 3 mm is recommended for the following format with anti-slip finish: 48.8 x 97.9 cm. When it's necessary to modulate field tiles ref. 316 (31 x 62.6 cm) with trim pieces, the joint should be 6 mm. The special piece also requires a joint between the pieces. The thickness of this joint will vary from 2mm to 6mm depending on the format of the piece.

## JOINT DE POSE MINIMUM (Pièces base)

Il est demandé un joint de pose minimum de 2mm pour les formats 48 x 98 lisse rectifiés et pour les formats 98 x 98 lisse et antidérapant rectifiés. Pour le format 48,8 x 97,9 en finition antidérapante le joint doit être d'au moins 3 mm.

Si vous souhaitez moduler les carreaux ref. 316 (31 x 62,6 cm) et les pièces spéciales, le joint devra être de 6 mm. La pièce spéciale requiert également un joint montage entre pièces. L'épaisseur de ce joint sera d'entre 2 mm et 6 mm selon le format de la pièce.

## CONDICIONES DE VENTA

La pieza base se facturará por m<sup>2</sup> y la pieza especial y decorada por unidades. Indugres y Aqua se facturará por unidades. / Para calcular el precio por m<sup>2</sup> y el número de piezas por m<sup>2</sup>, no se ha tenido en cuenta la junta de colocación <sup>(1)</sup>. / Los pedidos se ajustarán a cajas completas. / No se aceptarán reclamaciones del material colocado. / Las medidas están expresadas en cm. / El material viajará por cuenta y riesgo del comprador. / El comprador deberá comprobar el material dentro de los ocho días siguientes a su recepción. / El comprador perderá sus derechos de reclamación, si no los utiliza dentro de los seis meses siguientes a la recepción del material. / Rosa Gres garantiza la calidad de sus productos de 1ª calidad. / De común acuerdo nos reservamos la propiedad de la mercancía hasta el pago total del principal más los intereses. / Las piezas cumplen la norma EN-14411 (ISO 13006) del comité europeo de normalización. / Los palets, embalaje y retráctil se sirven sin cargo. / Para los productos porcelánicos se recomienda cemento cola de alta adherencia especial para este tipo de gres. / Los pesos específicos son pesos netos. Para calcular el peso bruto hay que añadir 20 kgs por palet en concepto de embalaje. / Una vez instalado el material, no se podrán hacer tratamientos a posteriori. Tampoco se podrán hacer limpiezas de fin de obra mediante medios mecánicos, ya que podrían alterar el antideslizamiento del material servido. / No se aceptan devoluciones.

<sup>(1)</sup> Excepto Indugres y Aqua

## SALES CONDITIONS

The field tiles will be invoiced by m<sup>2</sup>, except for the series Indugres and Aqua. The trim and decorated pieces will be invoiced by units. / The number of pieces per m<sup>2</sup> indicated in the packing list doesn't include the grout joint <sup>(1)</sup>. / Quantities will be adapted to complete boxes. / No refunds accepted on installed material. / The buyer will lose his right to claim if not exerted during the first six months after reception of goods. / Rosa Gres guarantees the quality of its products of 1st. choice. / Measurements are expressed in cm. / The buyer should verify the goods during the first eight days after their reception. / Title will be transferred to the purchaser only after the complete settlement of all his debits towards Rosa Gres / The pieces fulfill EN-14411 (ISO 13006) standards from the European normalization committee. / Packaging and pallets are free of charge. / For the porcelain quality products specially indicated high-adherence cement for this kind of tiles. To calculate the gross weight you must add 20 kgs for pallet and packaging. / No additional treatments can be applied once the material is in place, nor can the end of construction cleaning be performed by mechanical means, for it could alter the anti-slip qualities of the material. / Refused goods will not be accepted.

<sup>(1)</sup> Except Indugres and Aqua

## CONDITIONS DE VENTE

Nous facturons les pièces de base au m<sup>2</sup> et les pièces spéciales et pièces décorées par unité, sauf pour les séries Indugres et Aqua. / Pour calculer le prix et le nombre de pièces au m<sup>2</sup>, on ne prend plus en compte les joints de pose <sup>(1)</sup>. / Les commandes sont ajustées à la boîte complète. / Nous n'acceptons pas de réclamation une fois le matériel posé. Les dimensions sont exprimées en cm. / Nous nous réservons la propriété du matériel jusqu'à son paiement intégral. / Prix départ usine. / L'acheteur devra vérifier le matériel dans les huit jours suivant la réception. / L'acheteur perdra ses droits de réclamation 6 mois après la réception du matériel. / Rosa Gres garantit la qualité de ses matériaux de 1er choix. / Les pièces sont conformes à la norme EN-14411 (ISO 13006) du comité européen de normalisation. / Les palettes, conditionnement sous housse rétractable n'implique aucun supplément. / Avant la pose, nous conseillons de mélanger les pièces de plusieurs boîtes afin d'obtenir une finition plus uniforme. / Pour une pose en extérieur, demandez le guide correspondant. / Pour les matériaux en grès cérame, nous vous conseillons un ciment colle de haute adhérence, spécifique pour ce type de pièces. / Les poids spécifiques sont des poids nets. Pour calculer le poids brut, il faut ajouter 20 kgs par palette (emballages). / Une fois le matériel installé, aucun traitement ne peut plus se faire à posteriori. Éviter également d'utiliser des moyens mécaniques pour le nettoyage de fin de chantier, car ils peuvent endommager le matériau anti-dérapant. / Les retours ne seront pas acceptés.

<sup>(1)</sup> Sauf Indugres et Aqua

Rosa Gres declina toda responsabilidad en cuanto a errores tipográficos.

Rosa Gres declines all responsibility concerning typographical errors.

Rosa Gres déclinera toute responsabilité en ce qui concerne des possibles erreurs typographiques.

Las características de los modelos expuestos en esta tarifa pueden sufrir variaciones debidas a las continuas mejoras de los procesos de fabricación.

Features of items shown in this price list/catalogue are subject to change due to continuous improvement in our manufacturing processes.

Les caractéristiques des modèles dans ce catalogue peuvent être modifiées à cause des améliorations continuelles des processus de fabrication.

## IMPORTANTE | IMPORTANT

**Aqua y Indugres** se factura por unidades, tanto la pieza base como la pieza especial. El precio indicado es precio por pieza

**Aqua and Indugres** both field tiles and trim pieces will be invoiced per piece (not per m<sup>2</sup>). Indicated price is per piece.

**Aqua et Indugres** se facture par unités, la pièce de base comme la pièce spéciale. Le prix indiqué est le prix par pièce.

<b>Alma / Coral / Cuore / Iconic / Mistery / Mythos / Pietro / Serena / Sophy / Stela / Trésor</b>	<b>4</b>
<b>Indugres</b>	<b>10</b>
<b>Aqua</b>	<b>12</b>
<b>Sistema S9 / S9 System / Système S9</b>	<b>18</b>

UTILIZADOS PREFERENTEMENTE PARA VASO DE PISCINA. / USED PREFERABLY FOR POOL TANK. / UTILISÉ DE PRÉFÉRENCE POUR BASSIN DE PISCINE.

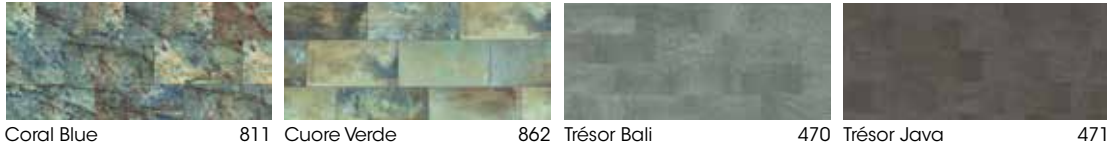

UTILIZADOS PARA EXTERIOR, INTERIOR Y VASO DE PISCINA / USED FOR OUTDOOR, INDOOR AND POOL TANK / UTILISÉ POUR EXTÉRIEUR, INTÉRIEUR ET BASSIN DE PISCINE



UTILIZADOS PREFERENTEMENTE PARA TERRAZA. APTOS PARA VASO DE PISCINA / USED PREFERABLY FOR TERRACES. SUITABLE FOR POOL TANK / UTILISÉ DE PRÉFÉRENCE POUR TERRASSE. CONVIENT POUR BASSIN DE PISCINE



	MMO Rectificado	MMO Rectificado	50M Rectificado	50M Anti-slip	50M 2cm Rectificado	316	316	316 Pastilla	199	310 BH 1-2	310 BH 1-2	316 NU 3
	97,9x97,9x1		48,8x97,9x1	48,8x97,9x1	48,8x97,9x2	31 x62,6x0,9		31 x62,6x0,9	19,4x97,9x1	31,3x31,3(4,9x4,9/u)		31 x62,6x0,9
	Liso	Anti-slip	Liso	Anti-slip	Anti-slip	Liso	Anti-slip	Pastilla	Anti-slip	Liso	Anti-slip	Anti-slip
€	<b>B-098</b>		<b>B-087</b>		<b>B-120</b>	<b>B-083</b>		<b>B-083</b>	<b>B-095</b>	<b>U-300</b>		<b>U-460</b>
Coral Blue								•				•
Cuore Verde								•				•
Trésor Bali								•				•
Trésor Java								•				•
Coral Sand		•		•				•				•
Cuore Rosso	•	•	•	•				•				•
Cuore Beige	•	•	•	•				•				•
Iconic White	•	•	•	•	•			•			•	•
Iconic Grey	•	•	•	•	•			•				•
Mistery White			•	•		•	•			•		•
Mistery Sand			•	•		•	•			•		•
Mistery Grey			•	•		•	•			•		•
Mistery Blue S.			•	•		•	•			•		•
Mythos Selene			•	•			•					•
Mythos Dune			•	•			•					•
Mythos Antique			•	•			•					•
Pietro White			•	•	•		•	•			•	•
Pietro Golden			•	•	•		•	•			•	•
Pietro Grey				•			•	•				•
Pietro Dark				•			•	•				•
Serena Bianco			•	•			•					•
Serena Odra			•	•			•					•
Serena Griggio							•					•
Serena Nero							•					•
Serena Mix							•			•		•
Sophy White	•	•	•	•			•					•
Sophy Beige	•	•	•	•			•					•
Sophy Grey	•	•	•	•			•					•
Alma Forest									•			
Alma Honey									•			
Alma Mist									•			
Alma Pure									•			
Stela White									•			
Stela Golden									•			
Stela Grey									•			
Stela Dark									•			
Packing												
x m²	22,53		22,53		46,25		20,45		22,36	-		20,45
x	2		3		1		6		6	9		6
x m²	1,04		2,09		2,09		5,15		5,26	-		5,15
m² x	1,917		1,433		0,4778		1,165		1,14	-		1,165
x	22		32		36		40		45	48		40
m² x	42,17		45,86		17,225		46,6		51,30	-		46,6
x	-		-		-		-		-	1,97		-

1 Mosaico enmallado de gres porcelánico / Porcelain mesh-mounted mosaic tiles / Mosaïque sur maille en grès cérame

2 Resto colores: Bajo pedido. Cantidad mínima 100 pzas / Other colors: available upon request. Minimum order: 100 pieces / Autres couleurs : sur commande. Quantité minimale : 100 pièces.

3 Números de profundidad / Depth tiles / Num. de profondeur

	Z62	ZLD	ZLI	L62	L98	DL1	DL2	E62	E98	ED6	E16	ED9	E19													
	62,6x7			36,5x30x7		62,6x31,7x3,8		97,9x31,7x3,8		31,7x31,7x3,8		62,6x62,6		97,9x97,9		62,6x31,7x3,8		97,9x31,7x3,8								
				Anti-slip		Liso		Anti		Anti-slip		Anti-slip		Anti-slip		Anti-slip		Liso		Anti		Liso		Anti		
€	E-055			E-073		E-137		E-163		E-166		E-144		E-179		E-202		E-179		E-192						
Coral Blue																										
Cuore Verde																										
Trésor Bali																										
Trésor Java																										
Coral Sand																										
Cuore Rosso																										
Cuore Beige																										
Iconic White																										
Iconic Grey																										
Mistery White																										
Mistery Sand																										
Mistery Grey																										
Mistery Blue S.																										
Mythos Selene																										
Mythos Dune																										
Mythos Antique																										
Pietro White																										
Pietro Golden																										
Pietro Grey																										
Pietro Dark																										
Serena Bianco																										
Serena Ocra																										
Serena Griggio																										
Serena Nero																										
Serena Mix																										
Sophy White																										
Sophy Beige																										
Sophy Grey																										
Alma Forest																										
Alma Honey																										
Alma Mist																										
Alma Pure																										
Stela White																										
Stela Golden																										
Stela Grey																										
Stela Dark																										
<b>Packing</b>																										
	0,97	0,83	0,83	6,5	10,19	2,25	3,25	9	16,8	7,23	7,23	10,48	10,48													
	20	20	20	4	2	3	3	2	1	2	2	2	2													
	41	41	41	24	30	30	30	32	30	32	32	20	20													

	183	188	114	115	116	117	147 <sup>1</sup>	030 <sup>2</sup>	040 <sup>3</sup>	S62	SI3	DS1			
	31 x 4 x 4		4 x 4				31 x 4 x 4				62,6 x 31 x 2,6	46 x 46 x 2,6	31 x 31 x 2,6		
	Liso	Anti	Liso	Anti	Liso	Anti	Liso	Anti	Liso	Anti	Liso	Anti	Anti-slip		
€	E-055		E-055		E-093		E-083		E-085		E-094		E-126	E-166	E-175
Coral Blue		•		•		•		•		•		•		•	
Cuore Verde		•		•		•		•		•		•		•	
Trésor Bali		•		•		•		•		•		•		•	
Trésor Java		•		•		•		•		•		•		•	
Coral Sand		•		•		•		•		•		•		•	
Cuore Rosso		•		•		•		•		•		•		•	
Cuore Beige		•		•		•		•		•		•		•	
Iconic White		•		•		•		•		•		•		•	
Iconic Grey		•		•		•		•		•		•		•	
Mistery White	•	•	•		•		•		•		•		•		•
Mistery Sand	•	•	•		•		•		•		•		•		•
Mistery Grey	•	•	•		•		•		•		•		•		•
Mistery Blue S.	•	•	•		•		•		•		•		•		•
Mythos Selene		•		•		•		•		•		•		•	
Mythos Dune		•		•		•		•		•		•		•	
Mythos Antique															
Pietro White		•		•		•		•		•		•		•	
Pietro Golden		•		•		•		•		•		•		•	
Pietro Grey		•		•		•		•		•		•		•	
Pietro Dark		•		•		•		•		•		•		•	
Serena Bianco		•		•		•		•		•		•		•	
Serena Ocra		•		•		•		•		•		•		•	
Serena Griggio		•		•		•		•		•		•		•	
Serena Nero															
Serena Mix		•		•		•		•		•		•		•	
Sophy White		•		•		•		•		•		•		•	
Sophy Beige		•		•		•		•		•		•		•	
Sophy Grey		•		•		•		•		•		•		•	
Alma Forest															
Alma Honey															
Alma Mist															
Alma Pure															
Stela White															
Stela Golden															
Stela Grey															
Stela Dark															
	Packing														
	0,43	0,55	0,08	0,05	0,11	0,12	0,55	0,57	0,57	7,46	5,93	3,80			
	18	14	34	70	30	30	14	18	14	4	1	3			
	102	102	-	-	-	-	102	102	102	24	-	30			

<sup>1</sup> Canto lateral romo / Half round piece with bullnose ending / Demi-canne avec bout arrondi

<sup>2</sup> Media caña interior con final ángulo recto / Interior half-round piece ending in a right angle / Demi-canne intérieure avec terminaison à angle droit

<sup>3</sup> Media caña exterior con final ángulo recto / Exterior half-round piece ending in a right angle / Demi-canne extérieure avec terminaison à angle droit



62,6x12,5x2,2 12,5x12,5x2,2 62,6x24,5x2,2 62,6x62,6x2,2 49,5x24,5x2,2 26,6x26,6x2,2 62,6x31x2,6 62,6x62,6x2,6 31x31x2,6 62,6x62,6x2,6 62,6x31x2,6 62,6x62,6x2,6 34,6x34,6x2,6 62,6x31x3,8

€	Anti-slip		Anti-slip											
	E-166	E-126	E-173	E-177	E-166	E-171	E-141	E-177	E-185	E-177	E-162	E-179		E-141
Coral Blue			•	•	•	•	•	•	•	•	•	•	•	•
Cuore Verde			•	•	•	•	•	•	•	•	•	•	•	•
Trésor Bali			•	•	•	•	•	•	•	•	•	•	•	•
Trésor Java			•	•	•	•	•	•	•	•	•	•	•	•
Coral Sand	•	•	•	•	•	•	•	•	•	•				
Cuore Rosso	•	•	•	•	•	•	•	•	•	•	•	•	•	•
Cuore Beige	•	•	•	•	•	•	•	•	•	•				
Iconic White	•	•	•	•	•	•	•	•	•	•	•	•	•	•
Iconic Grey	•	•	•	•	•	•	•	•	•	•	•	•	•	•
Mistery White	•	•	•	•	•	•	•	•	•	•	•	•	•	•
Mistery Sand	•	•	•	•	•	•	•	•	•	•	•	•	•	•
Mistery Grey	•	•	•	•	•	•	•	•	•	•	•	•	•	•
Mistery Blue S.	•	•	•	•	•	•	•	•	•	•	•	•	•	•
Mythos Selene	•	•	•	•	•	•	•	•	•	•	•	•	•	•
Mythos Dune	•	•	•	•	•	•	•	•	•	•	•	•	•	•
Mythos Antique	•	•	•	•	•	•	•	•	•	•				
Pietro White	•	•	•	•	•	•	•	•	•	•	•	•	•	•
Pietro Golden	•	•	•	•	•	•	•	•	•	•	•	•	•	•
Pietro Grey	•	•	•	•	•	•	•	•	•	•	•	•	•	•
Pietro Dark	•	•	•	•	•	•	•	•	•	•	•	•	•	•
Serena Bianco	•	•	•	•	•	•	•	•	•	•	•	•	•	•
Serena Ocra	•	•	•	•	•	•	•	•	•	•	•	•	•	•
Serena Griggio	•	•	•	•	•	•	•	•	•	•	•	•	•	•
Serena Nero	•	•	•	•	•	•	•	•	•	•				
Serena Mix	•	•	•	•	•	•	•	•	•	•	•	•	•	•
Sophy White	•	•	•	•	•	•	•	•	•	•	•	•	•	•
Sophy Beige	•	•	•	•	•	•	•	•	•	•				
Sophy Grey	•	•	•	•	•	•	•	•	•	•				
Alma Forest	•	•	•	•	•	•								
Alma Honey	•	•	•	•	•	•								
Alma Mist	•	•	•	•	•	•								
Alma Pure	•	•	•	•	•	•								
Stela White	•	•	•	•	•	•								
Stela Golden	•	•	•	•	•	•								
Stela Grey	•	•	•	•	•	•								
Stela Dark	•	•	•	•	•	•								

Packing														
	2,94	0,81	6,6	13,47	4,6	3,56	9,14	13,71	3,42	13,71	7,7	11,6	6,39	6,75
	5	4	4	1	4	4	4	1	3	1	4	1	1	4
	40	100	24	16	24	24	24	32	30	32	24	16	24	6,75

Complementos 121CM - E21 / Accessories 121CM - E21 / Accessoires 121CM - E21

PVC	CRA C1		<b>E-088</b>		0,60		6		48	<b>TRC C1</b>		<b>E-049</b>		0,06		20	-	<b>CCR C1</b>		<b>E-099</b>		0,18		6	-	<b>DCR C1</b>		<b>E-070</b>		0,17		20	-
-----	--------	--	--------------	--	------	--	---	--	----	---------------	--	--------------	--	------	--	----	---	---------------	--	--------------	--	------	--	---	---	---------------	--	--------------	--	------	--	----	---

EJE	IJ6	BR6	BR9	ECB	ER6	ER9	616	EEP	IEP	110	E56	056
4x4	31 x31 x31	62,6x50x2,6	97,9x50x2,6	52,8x52,8x2,6	62,6x62,6x2,6	97,9x97,9x2,6	62,6x26,2x3,7	62,6x62,6x3,7		24,4x2,5	5x4,3x0,9	62,6x5x9,9

Anti-slip

€	E-099	E-177	E-162	E-171	E-202	E-193	E-202	E-096	E-175	E-049	E-193	U-080
Coral Blue	•	•	•		•	•					•	•
Cuore Verde	•	•	•		•	•					•	•
Trésor Bali	•	•	•		•	•					•	•
Trésor Java	•	•	•		•	•					•	•
Coral Sand				•	•		•					
Cuore Rosso			•	•	•	•	•					
Cuore Beige												
Iconic White	•	•	•	•	•	•	•	•	•	•	•	•
Iconic Grey	•	•						•	•	•	•	•
Mistery White	•	•	•	•	•	•	•				•	•
Mistery Sand	•	•									•	•
Mistery Grey	•	•	•	•	•	•	•				•	•
Mistery Blue S.	•	•	•	•	•	•	•				•	•
Mythos Selene	•	•									•	•
Mythos Dune	•	•	•	•	•	•	•				•	•
Mythos Antique											•	•
Pietro White	•	•	•	•	•	•	•	•	•	•	•	•
Pietro Golden	•	•	•	•	•	•	•	•	•	•	•	•
Pietro Grey	•	•	•	•	•	•	•	•	•	•	•	•
Pietro Dark	•	•	•	•	•	•	•	•	•	•	•	•
Serena Bianco	•	•									•	•
Serena Ocra	•	•	•		•	•					•	•
Serena Griggio	•	•									•	•
Serena Nero											•	•
Serena Mix	•	•	•		•	•					•	•
Sophy White			•	•	•	•	•				•	•
Sophy Beige											•	•
Sophy Grey											•	•
Alma Forest				•	•		•					
Alma Honey												
Alma Mist												
Alma Pure												
Stela White												
Stela Golden												
Stela Grey												
Stela Dark												
blanco											•	

Packing

	0,07	5,06	12	19,5	12,51	14,41	29,04	7,5	11,86	11,86	0,24	1,45	0,66
	48	2	3	2	2	2	1	4	2	2	40	1	36
	100	32	8	20	8	8	20	24	24	24	108	99	40

Complementos Sistema Minimal / Minimal System Accessories / Accessoires Système Minimal

ACERO	PSM		E-139	BLANCO GRIS	JSM		E-076	JSM: 10 metros / rollo 10 meters / roll 10 mètres / rouleau
-------	-----	--	-------	-------------	-----	--	-------	----------------------------------------------------------------------

# Indugres

100% **Biostop**



**EL GRES PORCELÁNICO ANTIÁCIDO QUE ELIMINA LAS BACTERIAS**

**THE ANTACID PORCELAIN STONEWARE THAT OFFERS CONTINUOUS MICRO INHIBITION**

**LE GRÈS CÉRAME ANTI ACIDE AVEC UNE ÉLIMINATION CONTINUE DES BACTÉRIES**



	122 G3	240 G3				244 G1	140	037	038	013	112	138	114	115
	11,9x24,4x1	24,4x24,4x1				24,4x49,4x0,8	24,4x12x4	12x4x4	12x7x7	24,4x11,9	24,4x4x4		4x4	
€	U-045	U-090	U-090	U-130	U-130	U-165	E-060	E-094		E-056	E-051	E-051	E-093	
Indubeige R9	•						•	•	•	•	•	•	•	•
Indubeige R10		•												
Indubeige R12			•											
Indu Grey R10				•			•	•	•	•	•	•	•	•
Indu Grey R12					•									
Blanco <sup>1</sup>						•				•	•	•	•	•
<b>Packing</b>														
x	0,65	1,37				2,25	0,96	0,22	0,24	0,65	0,42	0,34	0,08	0,05
x	32	16				10	10	20	8	32	18	26	34	70
x	63	63				54	75	-	-	63	108	108	-	-
x m <sup>2</sup>	6mm <sup>2</sup>	32	16				8							
	2mm <sup>2</sup>	33,5	16,5				8,20							
m <sup>2</sup> x	6mm <sup>2</sup>	1	1				1,250							
	2mm <sup>2</sup>	0,955	0,955				1,250							
m <sup>2</sup> x		-	-				67,5							

<sup>1</sup> Tiene prestaciones Biostop / It has Biostop properties / Il possède des propriétés Biostop.  
<sup>2</sup> Ancho de la junta de colocación / Grout joint width / Largeur du joint



Juntas de colocación / Sealing grout / Join de posé

	€	N-174	N-135
	Bio Cerpoxi White 21 kg	•	
	Bio Cerpoxi Grey 21 kg		•





Consumos aproximados / Approximate consumption / Consommation approximative



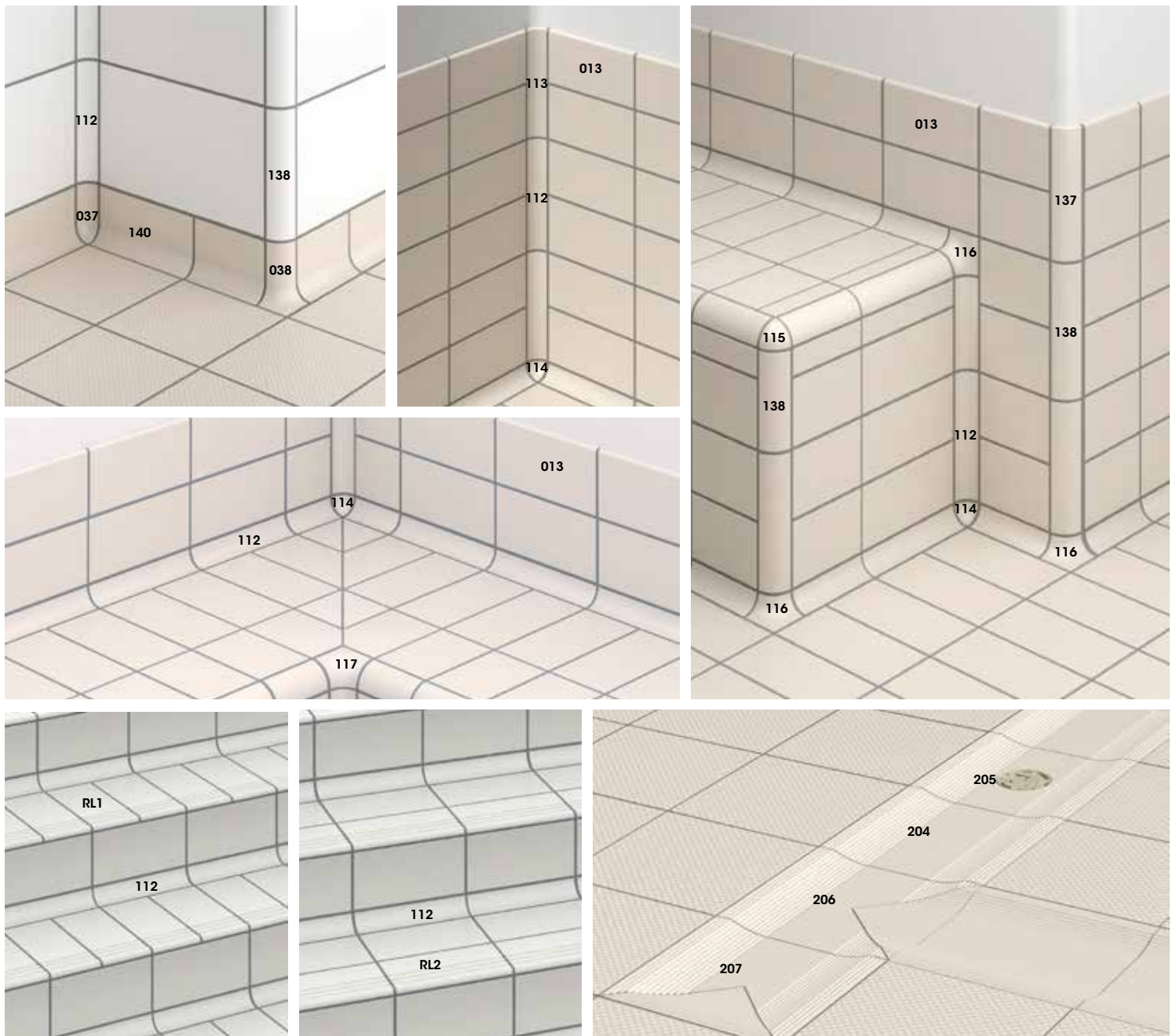





Format	6mm	2mm
24,4 x 24,4 x 1	0,79 kg/m <sup>2</sup>	0,26 kg/m <sup>2</sup>
24,4 x 49,4 x 0,8	0,47 kg/m <sup>2</sup>	0,16 kg/m <sup>2</sup>

	116	117	113	137	RL1	RL2	204	205	206	207	413
	4x4		24,4x4x4		11,9x24,4	24,4x11,9	24,4x24,4x2,4				24,4x49,4x0,9
€	E-083		E-085		E-058		E-079	E-164	E-140		E-073
Indubeige R9	•	•	•	•							
Indubeige R10					•	•	•	•	•	•	•
Indubeige R12					•	•					
Indu Grey R10	•	•	•	•	•	•	•	•	•	•	•
Indu Grey R12					•	•					
Blanco <sup>1</sup>	•	•									•
Packing											
	0,11	0,12	0,41	0,27	0,65	0,65	2	1,98	1,98	2,26	2,40
	30	30	18	26	32	32	6	6	6	6	8
	-	-	108	108	63	63	63	63	63	-	36











<sup>1</sup> Tiene prestaciones Biostop / It has Biostop properties / Il possède des propriétés Biostop.

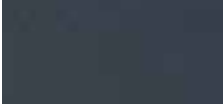
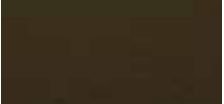
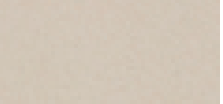

	240 G1	244 G1				122 G1				052 G1		310 AP		
														
	24,4x24,4x0,8	24,4 x49,4x0,8				11,9x24,4x0,8				5,6x24,4x0,8		30,8x30,8x1		
	Pastilla	Liso		Anti-slip		Liso		Anti-slip		Liso		Liso	Anti-slip	
€	U-090	U-155	U-165	U-215	U-215	U-180	U-030	U-035	U-055	U-055	U-045	U-040	U-055	U-275
Azul		•				•	•				•	•		•
Blanco			•			•		•			•	•		•
Marino			•			•		•			•	•		•
Plomo			•			•		•			•	•		•
Habana				•	•				•	•			•	
Prusia				•	•				•	•			•	
Oliva				•	•				•	•			•	
Amarillo				•	•				•	•			•	
Rojo N				•	•				•	•			•	
Indubeige Pastilla	•													
Plomo Pastilla	•													

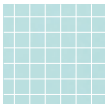
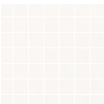
Packing							
 x 	0,99	2,25		0,53		0,24	1,45
 x 	21	10		42		30	10
 x m <sup>2</sup>	16 <sup>1</sup>	8 <sup>1</sup>		32 <sup>1</sup>		64 <sup>1</sup>	-
m <sup>2</sup> x 	1,312 <sup>1</sup>	1,250 <sup>1</sup>		1,312 <sup>1</sup>		0,468 <sup>1</sup>	-
 x 	63	54		63		144	48
m <sup>2</sup> x 	82,69	67,5		82,53		67,50	-

<sup>1)</sup> Con junta de colocación de 6 mm / With a 6 mm wide grout joint / Avec un jointolement à 6 mm

					
azul 841	blanco 845	marino 843	plomo 852	habana 072	prusia 074
					
oliva 871	amarillo 630	rojo N 626	Mosaic Azul 310 AP	Mosaic Blanco 310 AP	Mosaic Marino 310 AP
					
plomo pastilla 852	indubeige pastilla 672				

Número de piezas por m<sup>2</sup> según ancho de junta  
 Number of pieces by m<sup>2</sup> depending on grout joint width  
 Nombre de pièces par m<sup>2</sup> en fonction de la largeur du joint

Format	6mm	2mm
11,9 x 24,4	32	33,5
24,4 x 24,4	16	16,50
24,4 x 49,4	8	8,20



ERGO							ERGO MONOCOLOR								
216	044	E42	175	176	07S	035	216	044	E42	175	176	07S	035		
24,4x26,2	26,2x26,2	24,4x24,4	11,9x 26,2	24,4x13,9	24,4x13,4		24,4x26,2	26,2x26,2	24,4x24,4	11,9x 26,2	24,4x13,9	24,4x13,4			
Anti-slip															
€	E-093	E-094	E-164	E-166	E-082	E-070	E-088	E-093	E-094	E-164	E-166	E-077	E-070		
Azul	•	•	•	•	•	•									
Blanco	•	•	•	•	•	•									
Indubeige	•	•	•	•	•	•									
Marino							•		•	•	•	•	•		
Plomo								•	•	•	•	•	•		
Packing															
	3,09	3,61	2,68	1,44	1,44	1,30	0,9	3,09	3,09	3,61	2,68	1,44	1,44	1,30	0,9
	5	3	3	5	5	8	12	5	5	3	3	5	5	8	12
	51	-	-	-	-	57	57	51	51	-	-	-	-	57	57

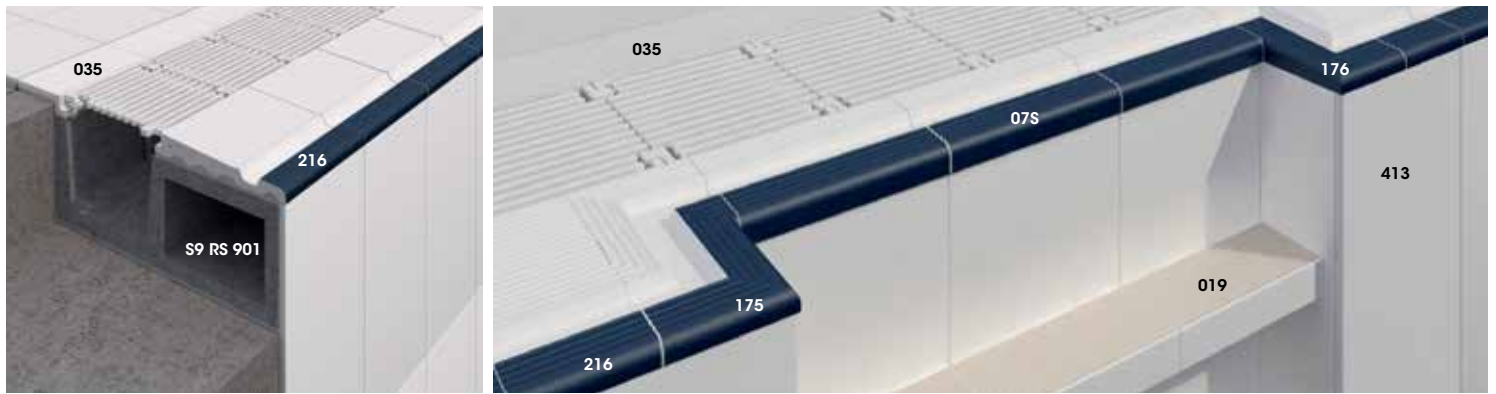

FINLANDES							FINLANDES MONOCOLOR								
007	087	088	043	07S	88S	43S	001	007M	087M	088M	043M	07SM	88SM	43SM	
24,4x11,9	24,4x24,4	11,9x11,9	24,4x13,9	13,9x13,9	24,4x24,4x2,4	11,9x24,4	24,4x11,9	24,4x24,4	11,9x11,9	24,4x13,9	13,9x13,9	24,4x24,4			
Anti-slip															
€	E-077	E-114	E-126	E-082	E-091	E-088	E-009	E-069	E-099	E-085	E-077	E-114	E-085		
Azul	•	•	•	•	•	•	•								
Blanco	•	•	•	•	•	•	•								
Indubeige	•	•	•	•	•	•	•								
Marino							•	•	•	•	•	•	•		
Plomo								•	•	•	•	•	•		
Packing															
	1,18	1,78	0,6	0,55	1,3	0,69	1,78	0,49	1,18	1,78	0,60	0,55	1,3	0,69	1,78
	7	2	8	9	8	4	2	42	7	2	8	9	8	4	2
	108	-	-	-	57	99	99	63	108	-	-	-	4	99	99

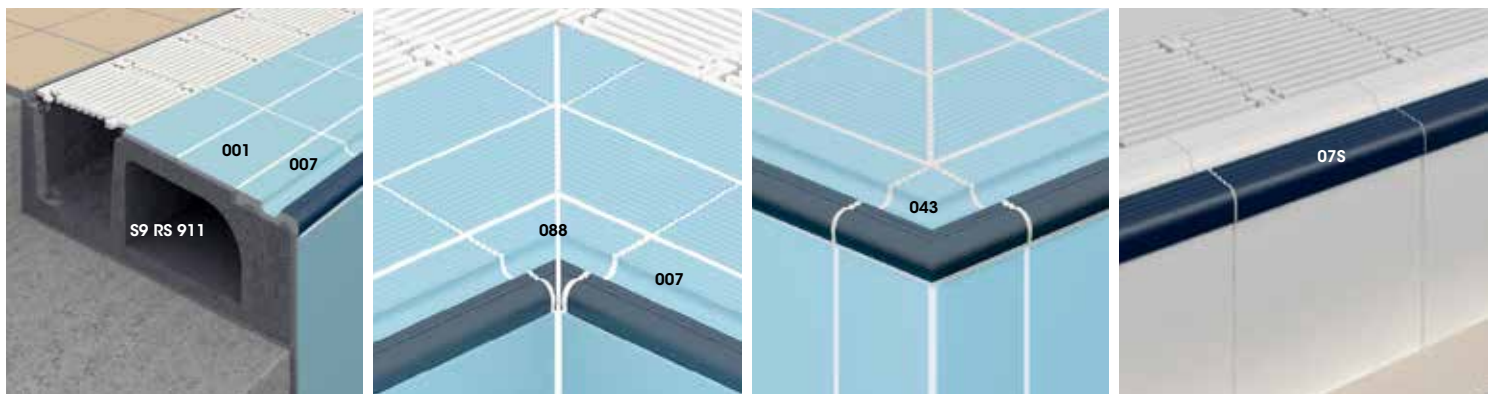

HORYZON						WIESBADEN		
R49	R51	R5E	G49	O89	E45	971	973	972
49,4x29,7x0,9	36,7x36,7x0,9	42,3x42,3x0,9	49,4x11,9x2,4	11,9x11,9x2,4	24,4x24,4x2,4	24,4x12	11,9x11,9	11,9x11,9

Anti-slip

€	E-070	E-117		E-092	E-114	E-164	E-073	E-080	E-101	E-117	E-101	E-117
Azul	•	•	•	•	•	•	•		•		•	
Blanco	•	•	•	•	•	•	•		•		•	
Marino	•	•	•	•	•	•	•		•		•	
Plomo	•	•	•	•	•	•		•		•		•

Packing

	2,7	2,7	3,37	2,30	0,57	1,5	1,22	1,22	1,22	1,22	1,22	1,22
	8	4	4	4	8	4	8	5	5	5	5	5
	36	-	-	90	-	-	84	-	-	-	-	-

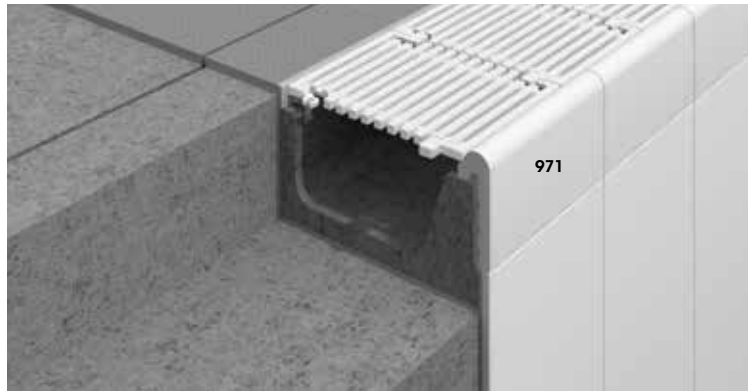
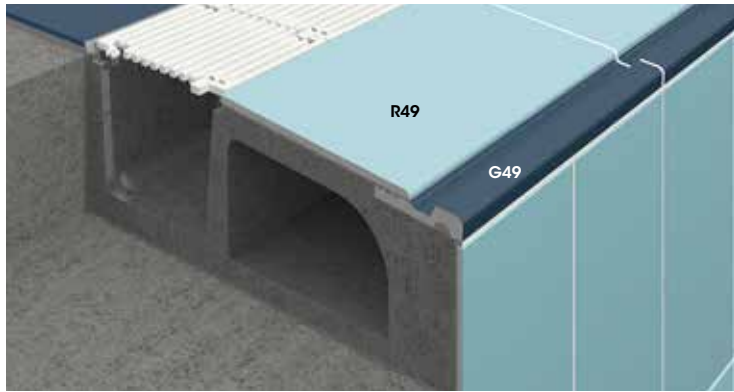

R49 RM	413	013	E13	009	019	122 N9				C01 / C08	122 P0 122 P8	122 P9	003	027	
49,4x29,7x0,9	49,4x24,4x0,9	24,4x11,9	11,9x11,9	11,9x24,4	24,4x9,6	11,9x24,4				24,4x24,4	11,9x24,4		24,4x11,9	11,9x11,9	
Anti-slip	Liso	Liso	Anti	Anti-slip	Liso	Anti	Anti-slip	Liso	Anti	Liso	Anti	Liso	Anti	Anti-slip	Anti-slip

€	E-070		E-056		E-093	E-067		E-084	U-450		U-350 <sup>1</sup>		U-400	U-350		U-450	E-058	E-094
Azul	•	•	•	•		•	•	•	•	•	•	•	•	•	•	•	•	
Blanco	•	•	•	•		•	•	•	•	•	•	•	•	•	•	•	•	
Indubeige			•	•					•	•	•	•					•	
Marino		•	•	•	•												•	•
Plomo		•	•	•	•													

Packing

	2,73	2,25	0,53	0,30	0,59	1,81	0,53		1,07	0,53	0,53	0,55	0,30
	8	8	20	20	20	4	-		-	-	-	18	20
	36	36	108	-	108	81	-		-	-	-	108	-

<sup>1</sup> Números acabados en cero / Numbers finished in zero / Numéros finis in zero

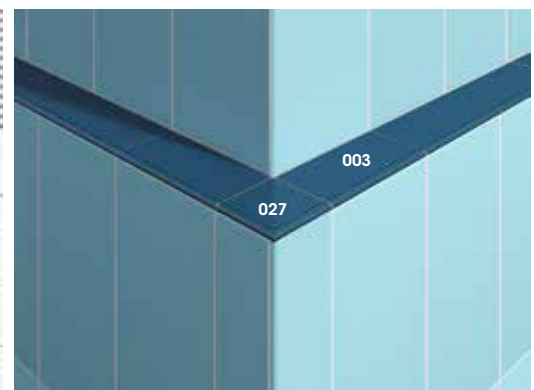
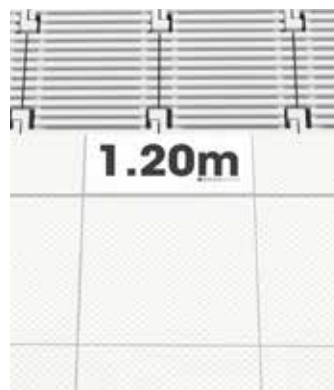
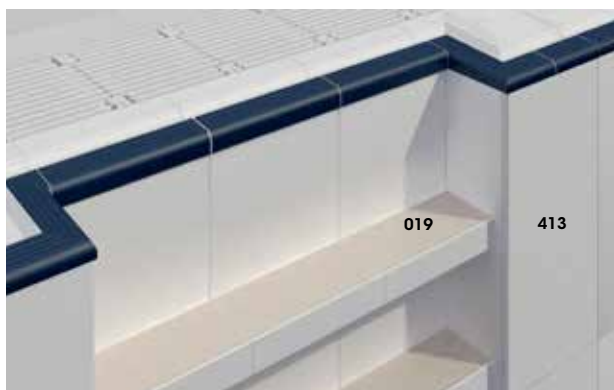

112	138	010	020	114	115	116	117	204	205	206	207
-----	-----	-----	-----	-----	-----	-----	-----	-----	-----	-----	-----









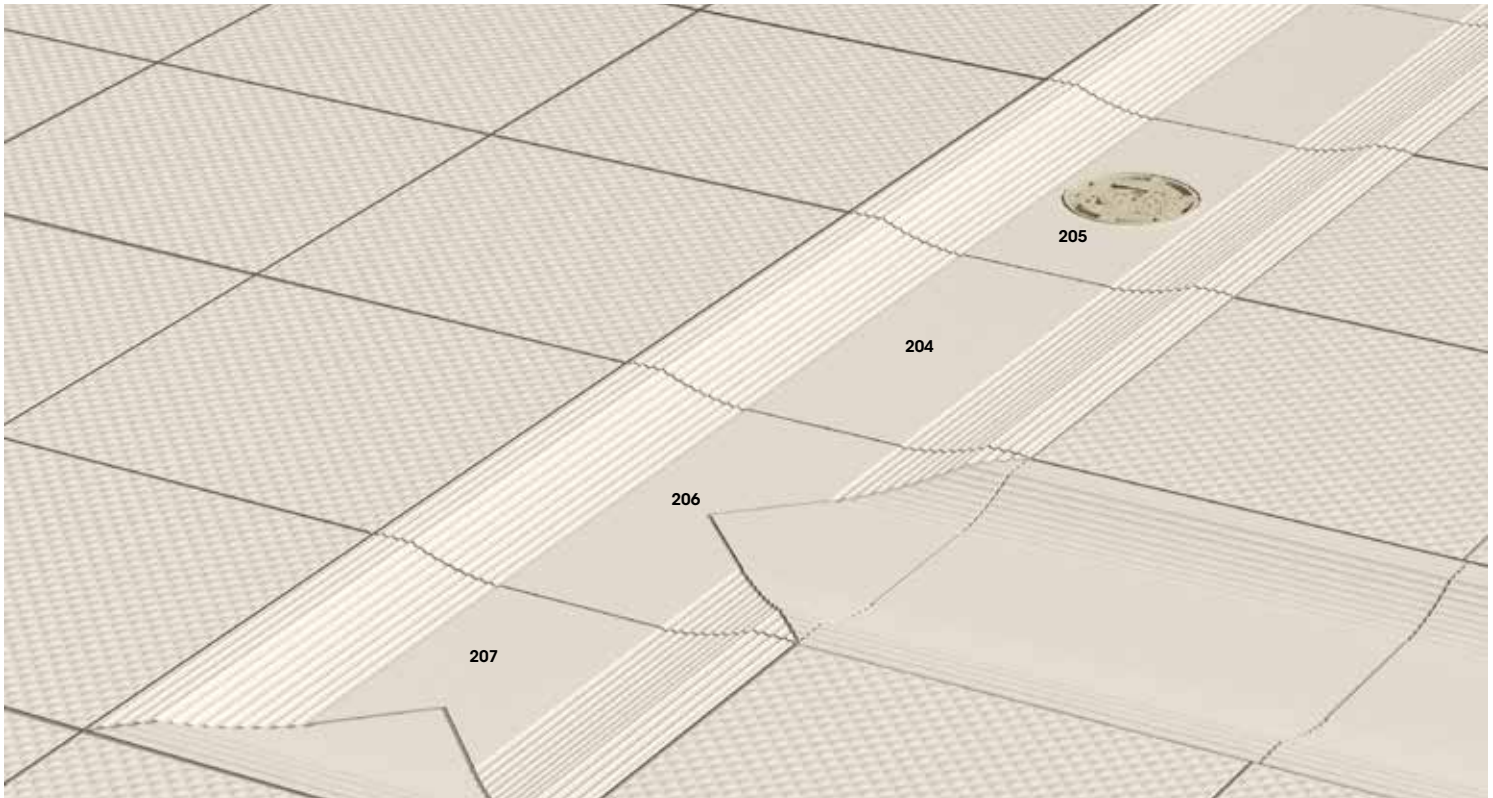
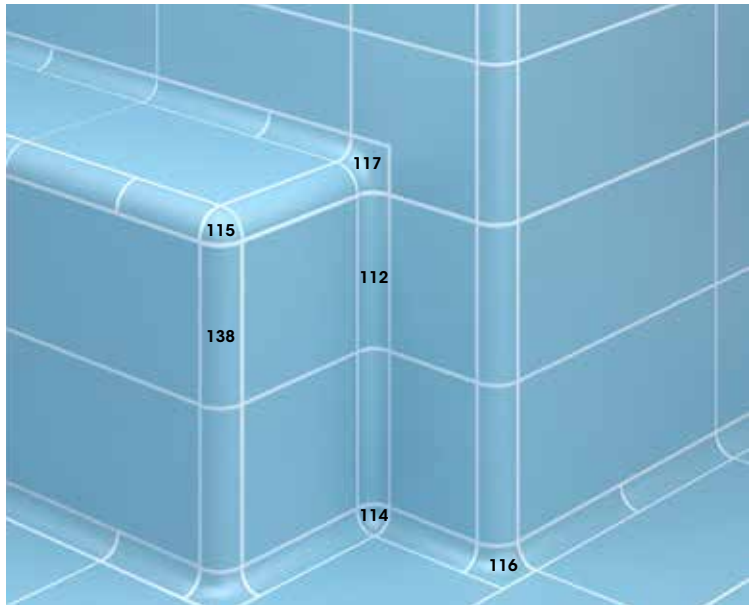

€	24,4x4x4				4x4				24,4x24,4x2,4			
	Liso	Liso	Anti	Liso	Liso	Anti-slip	Liso	Anti-slip	Anti-slip			
	E-051	E-051		E-162	E-093		E-083		E-079	E-164	E-140	

Azul	•	•	•	•	•	•	•	•				
Blanco	•	•	•	•	•	•	•	•				
Indubeige	•		•		•	•	•	•	•	•	•	•
Marino	•	•	•		•	•	•	•				
Plomo	•		•		•	•	•	•	•	•	•	•







	Packing											
x	0,42	0,34	0,45	0,45	0,08	0,05	0,11	0,12	2	1,98	1,98	2,26
x	18	26	18	24	34	70	30	30	6	6	6	6
x	108	108	-	99	-	-	-	-	63	-	-	-





REJILLAS / GRATING / GRILLE

Rejilla Grating Grille			Rejilla Longitudinal Longitudinal Grate Grille Longitudinale				KIT Terminal Longitudinal End Piece for Longitudinal grat Embout pour Grille Longitudinale				Perfil Soporte mil Grating support profile Profil support grille	
245 R2	295 R2	335 R2	195 L2	245 L2	295 L2	345 L2	195 T0	245 T0	295 T0	345 T0	243 PF <sup>1</sup>	
												
24,5x19,5x2,2	29,5x19,5x2,2	33,5x19,5x2,2	19,5x20,6x2,4	24,5x20,6x2,4	29,5x20,6x2,4	34,5x20,6x2,4	19,5x2,4	24,5x2,4	29,5x2,4	34,5x2,4	2,4x3,7x200	
€	C-046	C-048	C-050	C-056		C-058		C-090	C-091	C-092		C-085
Blanco	.	.	.	.	.	.	.	.	.	.	.	.

REJILLAS / GRATING / GRILLE

Curvas y rectas Modular Grate for Bends Grille pour Courbes								Placa Esquina 90° 90° Corner Plastic Piece Angle pour Caillebotis 90°							
195 V2	245 V2	295 V2	335 V2	195 V3	245 V3	295 V3	335 V3	195 E2	245 E2	295 E2	335 E2	195 E3	245 E3	295 E3	335 E3
															
19,5 x 2,2	24,5 x 2,2	29,5 x 2,2	33,5 x 2,2	19,5 x 3,5	24,5 x 3,5	29,5 x 3,5	33,5 x 3,5	19,5 x 19,5 x 2,2	24,5 x 24,5 x 2,2	29,5 x 29,5 x 2,2	33,5 x 33,5 x 2,2	20 x 20 x 3,5	25 x 25 x 3,5	30 x 30 x 3,5	34 x 34 x 3,5
€	C-009	C-010	C-011	C-012	C-009	C-010	C-012	C-083	C-098	C-100	C-103	C-090	C-098	C-101	C-104
Blanco	.	.	.	.	.	.	.	.	.	.	.	.	.	.	.

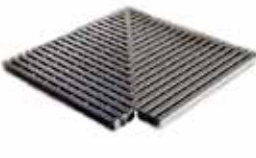
REJILLAS / GRATING / GRILLE

Rejilla Grating Grille	Placa Esquina 90° 90° Corner Plastic Piece Angle pour Caillebotis 90°	Rejilla Longitudinal Longitudinal Grate Grille Longitudinale	Curvas y rectas Modular Grate for Bends Grille pour Courbes
245 R2 <sup>2</sup>	245 E2	245 L2	245 V2
			
24,5x250x2,4	24,5x24,5x2,4	24,5x100x2,4	24,5x24,5x2,4
€	C-109	C-112	C-111
Plomo	.	.	.
Satén	.	.	.





OTRAS OPCIONES / OTHER OPTIONS / AUTRES OPTIONS

Anclaje polipropileno Polypropylene anchorage Ancrage en polypropylène	Desagüe PVC PVC Drains Drain PVC	Silenciador de desagüe 2 <sup>1/2</sup> " Drain silencer 2 <sup>1/2</sup> " Silencieux 2 <sup>1/2</sup> "	PP homopolímero PP Homopolymer
ANEH 1	990	DS2	EMB 00
			
C-058	E-084	E-166	E-098
			Beige Plomo Perla Blanco

<sup>1</sup>Se necesitan 2 unidades para sujetar la rejilla - Se venden por piezas de 2 m / 2 units required to hold the grid - Sold in units of 2 m / Il faut 2 unités pour supporter la grille - Vente par pièces de 2 m

<sup>2</sup>Se venden por piezas de 2'5 m / Sold in units of 2'5 m / Vente par pièces de 2'5 m

CORCHERAS / FLOATING LINES / LIGNE SEPARATION COULOIRS

Corchera modelo Cork floats line Ligne separation colour		Anclaje inclinado Sloping anchorage Ancrage incliné		Anclaje plano Flat anchorage Ancrage plat		Soporte corchera Cork floats holder Support ligne séparation couloirs	Copa anclaje Anchor cup Coupe d'ancrage	Anclaje tornillo Screw anchor Vis d'ancrage	
ROMM2 <sup>1</sup>	ROMM5 <sup>1</sup>	ANIH1	ANIH2	ANPH1	ANPH2	SPCH1	CAE00	ANTH1	
									
25	50	Ø43 Tubo / Tube Tubez	Ø48 Tubo / Tube Tubez	Ø43 Tubo / Tube Tubez	Ø48 Tubo / Tube Tubez	Ø43 Anclaje / Anchorage Ancrage	Anclaje escamotable Retractable anchor Ancre rétractable	Ø43 Tubo / Tube Tubez	
€	<b>C-157</b>	<b>C-177</b>	<b>C-118</b>	<b>C-124</b>	<b>C-118</b>	<b>C-121</b>	<b>C-104</b>	<b>C-113</b>	<b>C-129</b>

ESCALERAS / STAIRS / ESCALIERS

Escalera con pasamanos modelo 1000 Stair with handrail model 1000 Échelle avec rampe modèle 1000		Escalera modelo partida Model split stairs Échelle avec rampe séparée		Escalera partida modelo ergo Stair with handrail ergo model Échelle séparée modèle ergo		Escalera asimétrico Asymmetric stair Échelle asymétrique	Salidas anclaje interior / exterior External / internal holder exits Sorties ext. / int. pour encastrer
MILX3	MILX4	PTDX3	PTDX4	EPEZ3	EPEZ4	SMA00	PAS00
							
3 Peldaños / Steps Marches	4 Peldaños / Steps Marches	3 Peldaños / Steps Marches	4 Peldaños / Steps Marches	3 Peldaños / Steps Marches	4 Peldaños / Steps Marches	2 Pasamanos Handrail Rampes	Ø43 Acero Inox / Steel Inox Acier Inox
<b>C-167</b>	<b>C-168</b>	<b>C-149</b>	<b>C-151</b>	<b>C-158</b>	<b>C-160</b>	<b>C-159</b>	UNDER REQUEST

SEÑALIZACIÓN / SIGNS / SIGNALISATION

Señalización salida falsa para postes False start signaling for poles Signalization faux départ			Banderines Signal flags Poteaux fanions			Podium salida nadadores Swimmers' start podium Podium nageurs	Elevador hidráulico Hydraulic elevator Élévateur hydraulique	
SS FH 1 <sup>1</sup>	SS FH 2 <sup>1</sup>	SS FCC 1 <sup>1</sup>	BDNH1 <sup>1</sup>	BDNH2 <sup>1</sup>	BDNBC <sup>1</sup>	PDH7 <sup>2</sup>	ELV65	ELVML
								
Ø43 Postes / Poles Poteaux	Ø48 Postes / Poles Poteaux	Cuerda poliester Polyester rope Corde polyester	Ø43 Postes / Poles Poteaux	Ø48 Postes / Poles Poteaux	2 Cuerdas y bandera Strings and signal flags Cordes et fanions	70 cm Azul - Altura Blue - High / Bleu - Hauteur	Pasamanos 650 Handrail / Rampes	Pasamanos 1000 Handrail / Rampes
€	<b>C-154</b>	<b>C-157</b>	UNDER REQUEST	<b>C-116</b>	<b>C-170</b>	UNDER REQUEST	<b>C-256</b>	<b>C-369</b>

SEÑALIZACIÓN / SIGNS / SIGNALISATION

Salvavidas Life preserver Bouée de sauvetage		Soporte Salvavidas Life preserver support Support bouée	Pie soporte Salvavidas Life preserver stand Support pied bouée de sauvetage
SAL PL	SAL LN	SSV00	PSV00
			
Plástico Plastic Plastique	Lona Canvas Toile		
<b>C-105</b>	<b>C-116</b>	<b>C-110</b>	<b>C-122</b>

<sup>1</sup> Anclajes no incluidos / Anchorage not included / Ancrages pas compris

<sup>2</sup> Numeración no incluida / Podium numbers not included / Numéros des podiums pas considérés

PRESTIGE SYSTEM

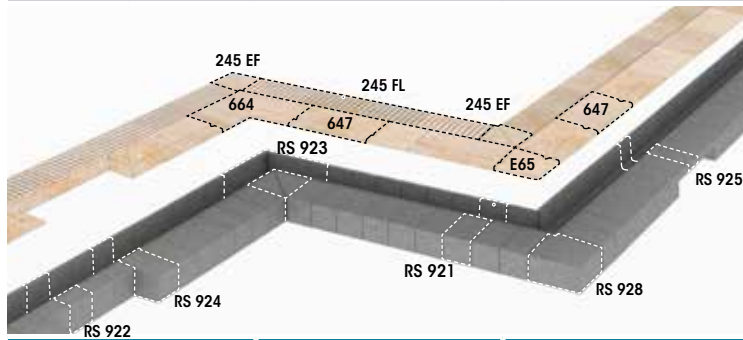

RS921	RS922	RS923	RS924	RS925	RS928
Base	Escalera abierta Open built-in stair Echelle ouverte	Esquina Interior Inside corner Angle intérieur	Maciza Solid Solide	Escalera cerrada Closed built-in stairs Echelle fermée	Esquina Exterior Outside corner Angle extérieur
55,9 x 19,5 x 20,6	37,2 x 19,5 x 20,6	55,4 x 55,4 x 20,6	55,9 x 19,5 x 20,6	55,4 x 19,5 x 20,6	35,8 x 35,8 x 20,6



€	S-020	S-056	S-107	S-056	S-111
---	-------	-------	-------	-------	-------

Packing

	19	16,17	56,84	33,32	33,32	46,06
	48	48	4	24	24	8

SMART SYSTEM

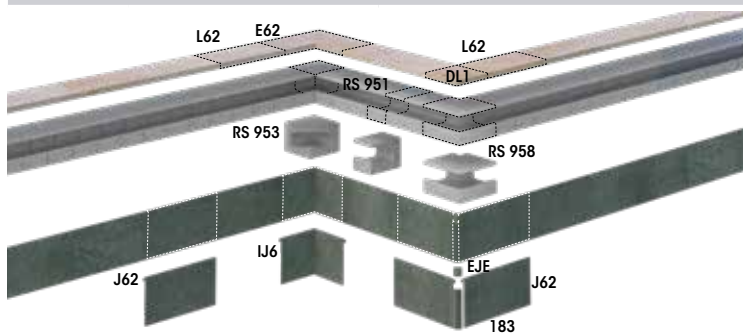

MINIMAL SYSTEM

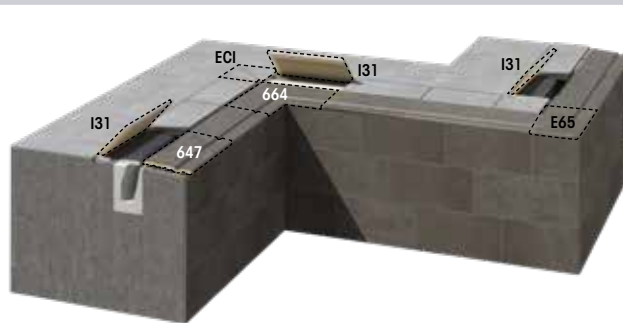

RS951	RS953	RS958	RS951 (Minimal system)
Base	Esquina Interior Inside corner Angle intérieur	Esquina Exterior Outside corner Angle extérieur	Base
29,7 x 19,5 x 20,8	55,4 x 55,4 x 20,6	55,9 x 19,5 x 20,6	29,7 x 19,5 x 20,8



€	S-020	S-107	S-115	S-020
---	-------	-------	-------	-------

Packing

	15,8	28,33	31,46	15,8
	60	40	40	60

ERGO SYSTEM

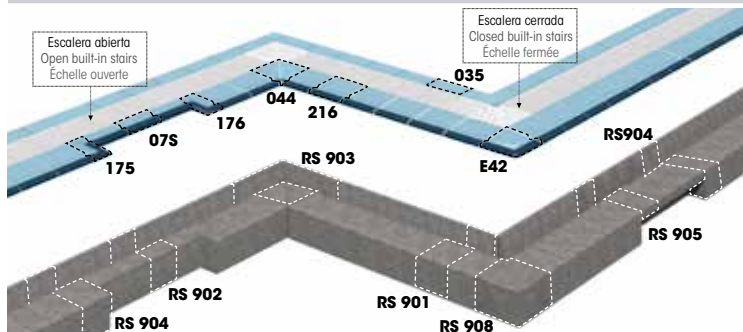

ERGO PLUS SYSTEM

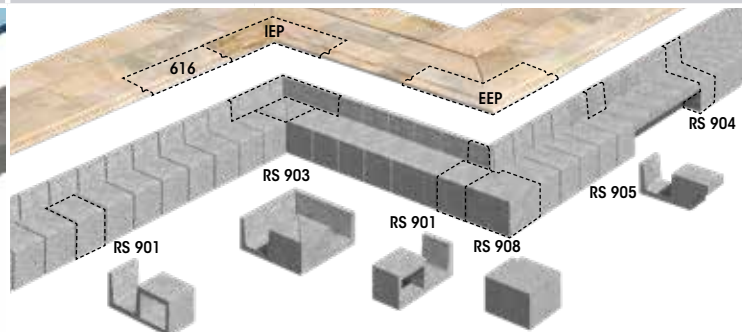

RS901	RS902	RS903	RS904	RS905	RS908
Base	Escalera abierta Open built-in stair Echelle ouverte	Esquina Interior Inside corner Angle intérieur	Maciza Solid Solide	Escalera cerrada Closed built-in stairs Echelle fermée	Esquina Exterior Outside corner Angle extérieur
49,6 x 19,5 x 18,9	36,8 x 19,5 x 18,9	49,6 x 49,6 x 18,9	49,6 x 19,5 x 18,9		29,5 x 29,5 x 18,9



€	S-013	S-053	S-101	S-053	S-107
---	-------	-------	-------	-------	-------

Packing

	19	16,17	56,84	33,32	33,32	46,06
	48	48	4	24	24	8

### FINLANDES SYSTEM

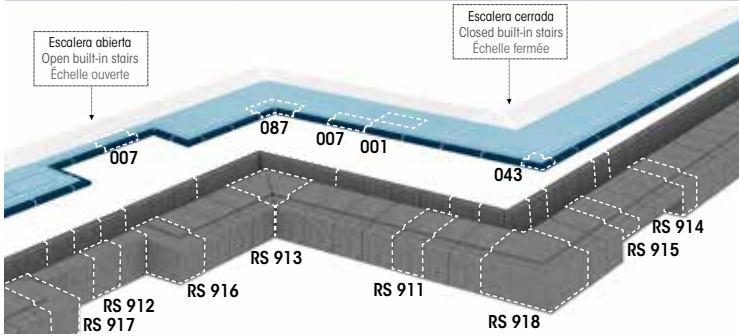

RS911	RS912	RS913	RS914
Base	Escalera abierta Open built-in stair Echelle ouverte	Esquina Interior Inside corner Angle intérieur	Maciza Solid Solide
61,2 x 19,5 x 21,5	37,2 x 19,5 x 21,5	61,2 x 61,2 x 21,5	



€	S-020	S-053	S-105
Packing			
	22	16,17	60,76
	40	48	4

### HORYZON SYSTEM

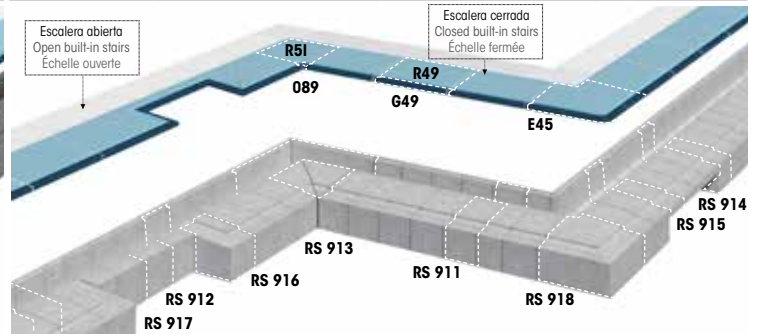

RS915	RS916	RS917	RS918
Escalera cerrada Closed built-in stairs Echelle fermée	Escalera abierta, esquina derecha Open built-in stairs, right corner Echelle ouverte coin droit	Escalera abierta esquina izquierda Open built-in stairs, left corner Echelle ouverte coin gauche	Esquina Exterior Outside corner Angle extérieur
	61,2 x 19,5 x 21,5		41,3 x 41,3 x 21,5



€	S-056			S-111
Packing				
	26,46	33,32	33,32	46,06
	16	8	8	8

### SLIM SYSTEM

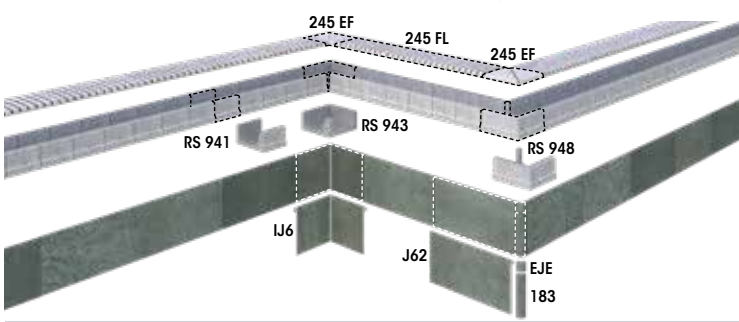

### WIESBADEN SYSTEM

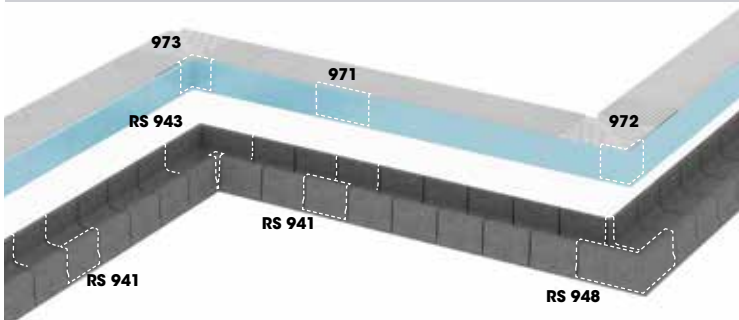

RS941	RS943	RS948
Base	Esquina Interior Inside corner Angle intérieur	Esquina Exterior Outside corner Angle extérieur
28 x 19 x 12,6		28 x 28 x 12,6



€	S-020	S-101
Packing		
	6,13	8,43
	128	54

### ZEN SYSTEM

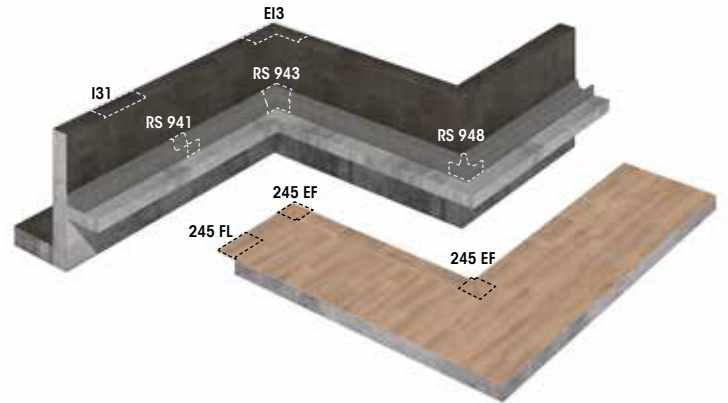

### SPA SYSTEM

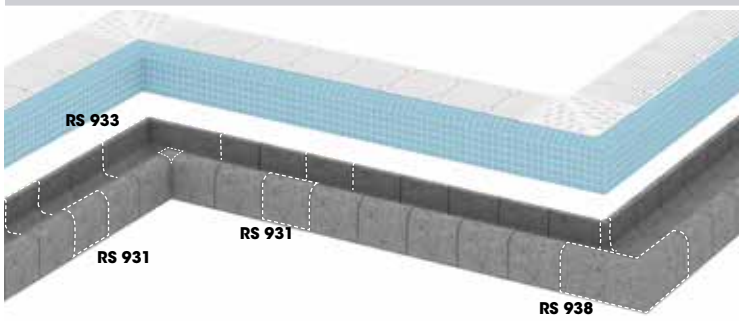

RS931	RS933	RS938
Base	Esquina Interior Inside corner Angle intérieur	Esquina Exterior Outside corner Angle extérieur
31,4 x 19 x 12,7	31,4 x 31,4 x 14,2	31,4 x 31,4 x 12,7



€	S-020	S-101
Packing		
	6,97	11,17
	96	42



Portada, Cover & Couverture: Pietro White / Contraportada, Back cover & Quatrième de couverture: Pietro White / EVA ARQUITECTURA



### Rosa Gres, SLU

#### Oficina Central - Central Office - Bureau Central

Ctra. Sant Cugat, km. 3  
08290 Cerdanyola, Barcelona, Spain  
Tel. + 34 93 586 30 60  
Ventas: + 34 93 586 37 00  
Export Sales: + 34 93 586 37 02  
info@rosagres.com  
www.rosagres.com

#### Rosa Gres France, SARL

64140 Lons, France  
Tel. + 33 04 11 92 00 30  
contact@rosagres.com  
administration@rosagres.com  
www.rosagres.com/fr

#### Fábrica - Factory - Usine

Pol. Ind. Mas Vell  
Ramón Sugrañes, 1  
43144 Vallmoll, Tarragona, Spain

Marzo 2026

